

reCollections

Caring for Collections Across Australia

CARING FOR CULTURAL MATERIAL 1



**HERITAGE
COLLECTIONS
COUNCIL**

Foreword	page	iii
A Note to Readers	page	iv
Introduction	page	v
Paper	page	1
Books	page	31
Photographs	page	67
Paintings	page	109
Electronic Information Media	page	131
Acknowledgments	page	143

© Commonwealth of Australia 1998 on behalf of the Heritage Collections Council

ISBN 0 642 37384 1 (boxed set)

ISBN 0 642 37385 X (this volume)

Information presented in this book may be reproduced in whole or in part for study or training purposes, subject to the inclusion of acknowledgment of source and provided no commercial usage or sale of material occurs. Reproduction for purposes other than those given above requires the written permission of the Heritage Collections Council. Requests for permission should be sent to the HCC Secretariat at the address given below.

One copy of this publication is available to Australian institutions on application. Multiple copies to Australian institutions, copies to overseas institutions and copies to individuals will be charged at A\$100 plus postage and handling. Copies may be obtained by writing to:

Heritage Collections Council Secretariat

GPO Box 2154

Canberra ACT 2601

Australia

Phone (02) 6271 1094

Fax (02) 6271 1079

Email hcc@dcita.gov.au

This publication will be available online at the Australian Museums On Line website—
<http://amol.org.au>

Produced by the Commonwealth Department of Communications, Information Technology and the Arts.

Cover images (from left):

Detail of photograph courtesy of Museum of Western Australia.

Detail of bark painting, *Lightning Snake Story*, Douglas (Nawurapu) Wununmurra.
Photograph courtesy of Karen Coote, Australian Museum.

Detail of photograph courtesy of Artlab Australia.

Detail of hand-coloured 19th century children's book. Photograph courtesy of Vicki Humphrey.



HERITAGE
COLLECTIONS
COUNCIL

There are an estimated 41 million objects held in Australian museums, art galleries and historical collections. Collectively they tell the story of our history and our country and contribute to our sense of identity and national pride. Increasing the conservation skills of people who care for these collections is an important factor in protecting this heritage, and is a key goal of the Heritage Collections Council.

reCollections: Caring for Collections Across Australia has been developed with this goal in mind. This set of practical guidebooks is designed by the Council for use principally by non-conservators who are working with Australia's cultural heritage. The guidebooks are also a teacher-friendly resource which can be used in professional development workshops.

Many of Australia's most experienced conservators have been involved in researching, writing and editing **reCollections**, through the Conservation Training Australia consortium, led by Artlab Australia, which first developed the package, and through the Collections Management and Conservation Working Party of the Council.

The Heritage Collections Council's mission is to promote excellence in the management, care and provision of access to Australia's heritage collections so that together, they reflect Australia's cultural and natural diversity. The Council is a collaboration between the Commonwealth, State and Territory governments and the museums sector, and comprises people working in a wide range of cultural heritage institutions across the breadth of urban and regional Australia. **reCollections** is an important component of the Council's National Conservation and Preservation Strategy for Australia's Heritage Collections.

Rob Palfreyman
Chair
Heritage Collections Council

Heritage Collections Council

GPO Box 2154, Canberra ACT 2601, AUSTRALIA
Phone: (02) 6271 1094 Fax: (02) 6271 1079 Email: hcc@dcita.gov.au

A note to readers

reCollections: Caring for Collections Across Australia has been written by practicing conservators and is intended to provide a sound guide for the preventive care of cultural items. Active conservation treatment of cultural material should only be undertaken by, or on the advice of, a trained conservator. Before relying on any of the material in this guide, users should check its accuracy, currency, completeness and relevance for their purposes and should obtain appropriate professional advice.

***If in doubt,
consult a
conservator***

To obtain the names of accredited practicing conservators who are in a position to meet your particular conservation requirements contact the **Australian Institute for the Conservation of Cultural Material (Inc.)** a national organisation for conservators and people interested in the preservation of cultural material.

AICCM
GPO Box 1638
Canberra ACT 2601
National Secretary Phone: (02) 6254 8695
<http://home.vicnet.net.au/~conserv/aiccmhc.htm>

reCollections

Caring for Collections Across Australia

Our heritage is represented by a vast array of cultural material, from established national icons holding pride of place in major museums and galleries, to everyday items such as household appliances or newspapers which carry meaning for local communities or families. Yet so often the links to our heritage are tenuous because the objects which represent our culture are in danger of decay. However, there is a lot we can do to protect valued objects and collections and so prolong the life of our cultural heritage. ***reCollections: Caring for Collections Across Australia*** provides practical advice and guidance designed to help the reader care for their heritage.

reCollections explains how to apply preventive conservation techniques to cultural objects and collections. Preventive conservation optimises the environmental conditions in which objects and collections are housed. Controlling light and ultraviolet radiation, humidity and temperature, biological pests, and dust and pollutants helps to prevent damage and decay to cultural material. Preventive conservation also means ensuring that good handling, transportation, storage and display techniques are used at all times. Applying preventive methods to the care of cultural artefacts and collections can prolong and protect their life for current and future generations of Australians.

While ***reCollections*** provides conservation information about the care of cultural objects and collections, it is important to recognise that all except the simplest conservation treatments should be undertaken by trained conservators. Active conservation treatment is a response to the damage of cultural artefacts, a highly skilled field which often involves the use of chemicals and complicated technical procedures. Unless performed with a thorough knowledge of appropriate techniques and with the right equipment and materials, conservation treatments can do more harm than good to the objects being worked upon, and can be hazardous to the people performing the work. Conservation treatments should only be conducted by, or on the explicit advice of, a trained conservator.

To complement the preventive conservation advice contained in the volumes *Damage and Decay* and *Handling, Transportation, Storage and Display*, ***reCollections*** supplies detailed information concerning the care of some of the most common cultural materials. These range from the paper and other materials on which so much of Australia's cultural history may be seen, to special considerations in caring for Aboriginal and Torres Strait Islander cultural artefacts. In addition, modern practices concerning the management of collections and of the people who look after those collections are outlined.

PAPER

Objectives	page 3
Introduction	page 3
Paper in collections	page 3
What is paper?	page 4
Ingredients and properties of paper	page 4
What are the most common types of damage?	page 4
Common causes of damage	page 6
The do's and don'ts of handling flat paper	page 7
The do's and don'ts of repair and labelling	page 7
Guidelines for storing and displaying flat paper	page 8
Materials suitable for the storage and display of paper	page 9
Preparing flat paper for storage	page 10
Housing flat paper	page 11
Mounting/hinging flat paper	page 11
Protective enclosures for flat paper	page 15
Storage boxes for flat paper	page 18
Displaying flat paper	page 20
Framing flat paper items	page 21
Paper items with special needs	page 22
Papyrus and Parchment	page 23
Some miscellaneous information	page 23
Summary of conditions for storage and display	page 24
Paper in Australia's climatic zones	page 25
MORE ABOUT PAPER	
Cellulose fibres and paper quality	page 26
Acidity and alkalinity	page 27
For further reading	page 27
Self-evaluation quiz	page 27
Answers to self-evaluation quiz	page 29

Objectives

At the end of this chapter you should:

- understand the main factors that contribute to the deterioration of paper;
- be able to identify damage and deterioration of paper;
- understand how paper should be stored to minimise damage;
- understand how flat paper items should be displayed;
- have the necessary knowledge and practical skills to mount and frame paper items; and
- know how to make simple, protective enclosures for flat paper items.



Paper is the basic material for a wide variety of items in collections.

Photograph courtesy of the Ian Potter Art Conservation Service, University of Melbourne

Introduction

Paper is found in all collections. Its use is virtually universal. While not all paper is of equal importance, you will almost certainly have some items that need to be looked after. For example:

- valuable and significant items, such as works of art on paper and manuscripts;
- auxiliary material, such as the provenance documentation for other items in your collection; and

- material of particular importance to your organisation, such as documents relating to the setting up of your museum, gallery or library.

Of all the materials in your collections, flat paper items are perhaps the most vulnerable to damage and deterioration. Some flat paper materials have extremely fragile surfaces—such as pastel and charcoal drawings—and others are inherently unstable. And of course, all paper can be damaged by poor handling and lack of proper care.

This section provides information on how to protect your paper items. As the saying goes: prevention is better than cure; and nowhere is this truer than in the care of collections of flat paper items. Correct handling, storage and display are the linchpins of preventive care. The condition and lifespan of all flat paper items can be substantially improved if they are stored and displayed appropriately.

Paper in collections

Paper is used to make a wide range of objects, including:

- prints;
- maps;
- letters;
- documents;
- watercolours;
- drawings;
- technical drawings;
- posters;
- books;
- photographs;
- architectural plans;
- magazines;
- stamps;
- newspapers;
- archives.; and

This section deals with the care of flat paper items—items made of single sheets of paper.

For more information

Books and photographs have specific needs. For information on the care of books and photographs, please see the chapters on Books and Photographs in this volume.

What is paper?

Paper is made from cellulose fibres. Cellulose consists of long ribbon-like molecules held together in tightly-packed layers to form microfibrils. The microfibrils group themselves in bundles and numerous of these bundles go to form the paper fibre.

The fibres are suspended in water in the proportions of approximately 5% cellulose fibres to 95% water. The fibres are picked up on a mould, in the case of handmade paper, or on the web, in the case of paper-making machines. The mould and web are sieve-like in structure and allow the water to drain away, leaving a felted sheet of paper.

This fundamental process of paper-making has not changed since the first sheet of paper was produced in China around 200 BC.

Early European papers were made from the cellulose fibres from old rags. Later, fibres were extracted specifically to be used in paper-making. Paper fibres come from a range of plants, including:

- flax—also used to make linen;
- hemp—also used to make rope and military uniforms;
- cotton—also used to make fabrics;
- paper mulberry, daphne—Japanese paper-making fibres; and
- trees.

For more information

For more information on cellulose and paper, please see the section More About Paper, later in this chapter.

Ingredients and properties of paper

The type of plant fibres and the method of manufacture determine, to a large degree, the final characteristics of the paper. The most permanent papers are those made from plant fibres which are high in cellulose, such as cotton. A large percentage of the paper produced today is made

from ground wood. This paper is not intended to last and is used for ephemera, such as newspapers. Different quality wood-based paper products are available; and high-quality, long-lasting papers can be produced from wood pulp.

Besides fibres and water, paper usually contains products that are added during manufacture to give it certain properties. These include:

- fillers or loadings that produce a smoother surface and a whiter, more opaque paper. Kaolin or China clay, calcium carbonate and titanium dioxide have been used as fillers and loadings;
- coatings that are added to the surface of the paper to alter its characteristics. Minerals and other materials such as starch have been used as coatings; and
- sizes to reduce the absorbency of paper. Historically, gelatine was used as a size in European paper-making.

Most papers also contain impurities and unwanted chemicals—acids—that limit their lifespan. These acids are a major cause of deterioration and impermanence in paper. They can migrate from one paper to another, plus paper will pick up acids from other materials it touches. To overcome the problem with acids, there are now papers and paper-based products being produced that are free of acids and other impurities. These archival-quality products are made from various fibres, including cotton and specially-treated wood pulp. Many archival papers and boards also contain an alkaline buffer to help protect them from acidity.

Whenever possible, use archival papers to store and display other paper items.

For more information

For information about acids in paper and alkaline buffers, please see the section More About Paper, later in this chapter.

What are the most common types of damage?

Paper is vulnerable to physical damage and to the damage caused by chemical deterioration.

Physical damage includes problems such as:

- tears;
- paper losses;
- dog-eared corners;
- dents and punctures;
- creases and folds—paper can split along creases and folds if the paper is brittle or if it is folded and unfolded repeatedly;
- insect attack—paper, sizes and glues are good food sources for some insects. Mice and rats will also eat paper;
- abrasion and general wear and tear from excessive or careless use; and
- distortions caused by fluctuations and extremes of relative humidity and temperature in storage and display environments.

Damage from chemical deterioration includes:

- faded colours and discoloured paper—from exposure to UV radiation and high lighting levels;
- faded colours and discoloured paper—from age of the item itself or the items with which it comes in contact;
- mould attack—mould digests the materials it grows on;
- brittle paper—from the acids produced by the paper or the items with which it comes in contact; and
- damage from pollutants.

For more information

For more information about adverse environmental effects, please see *Damage and Decay*.

Recognising the problems

Some of the common forms of damage and deterioration in flat paper items are listed below. If the damage or deterioration is severe, isolate the item and get advice from a conservator.

Physical damage such as tears and losses can occur easily when items are handled roughly or stored in crowded conditions. Physical damage can also include abrasion, chipped corners, dents,

and punctures. Paper with mechanical damage should be handled carefully to avoid making the damage worse.



The edges of this print are torn and damaged, with losses at the corners.

Photograph courtesy of the Ian Potter Art Conservation Service, University of Melbourne

Creases and folds can disfigure and weaken paper. Old or brittle material is especially vulnerable because it can split and tear easily.

Foxing is the name given to the small, brown spots that appear in a specific area of the paper or over an entire surface. Foxing is usually caused by mould attack, brought on by a combination of high humidity, temperature and acidity. Other brown spots in the paper can be caused by inherent impurities such as tiny metal particles.



Heavy foxing disfigured this watercolour. The watercolour was treated and the foxing was reduced, but not fully removed.

Photograph courtesy of Artlab Australia, reproduced with permission of the Art Gallery of South Australia

Mould attack can take other forms, and nearly always leaves stains and weakens the paper.

Soiling and staining can cause considerable damage to paper through:

- dirt particles, which are often acidic. These can be caught between the paper fibres, weakening and discolouring the paper, and creating a foothold for insects or mould; and
- self-adhesive sticky tapes, rusting clips and staples, and poor-quality adhesives. They can stain, cause severe damage and be extremely difficult to remove.



The edge of this print was stuck to a backing board with sticky tape, leaving heavy stains. The paper is also foxed.

Photograph courtesy of Vicki Humphrey

Discolouration, usually brown or yellow distributed evenly or unevenly throughout the paper, is a sign of deterioration that is generally caused by acidity and/or light damage to the paper. In artwork, the discolouration often appears worse in the margins



This work has been stained where it was in contact with poor-quality, acidic mount board.

Photograph courtesy of the Ian Potter Art Conservation Service, University of Melbourne

or on the reverse side, where the paper has been in direct contact with an acidic mount or other poor-quality materials. This discolouration is often referred to as 'mat burn'.

Brittle paper, which has become brown and is usually made of poor-quality or impermanent materials such as old newspaper, will deteriorate rapidly when exposed to light for lengthy periods and/or left in contact with other acidic material. Such paper can be extremely fragile and may disintegrate with unsupported movement or handling.

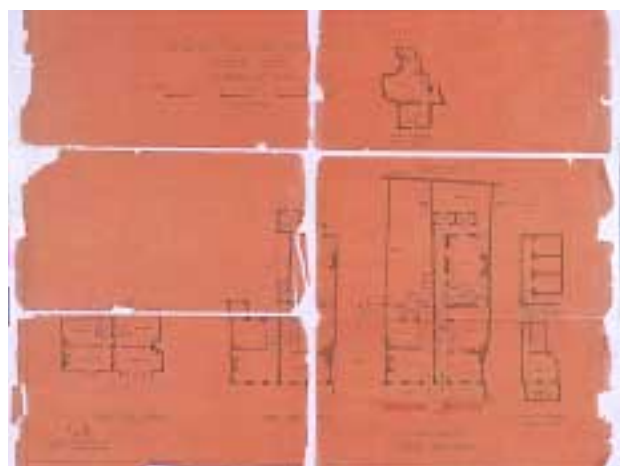

Brittleness has caused this plan to split along the folds.

Photograph courtesy of Vicki Humphrey

Common causes of damage

All the most common types of damage are caused by:

- poor handling;
- poor storage methods;
- inappropriate display methods;
- wear and tear from repeated use;
- chemical changes in the paper;
- chemical changes caused by chemicals that are present in the materials in contact with the paper or that are present as pollutants in the atmosphere; and
- combinations of any or all of the above.

A great deal of damage to paper can be prevented by care and pre-planning your handling, storage and display of flat paper items. The following sections will outline practical steps you can take to minimise this type of damage.

The do's and don'ts of handling flat paper

When handling paper, care and commonsense can help to prevent damage.

As a result, you should handle paper items with care, and as little as possible. It is also important to examine each sheet of paper for damage before handling.

Furthermore, all paper is fragile—even paper in good condition—so support it throughout use and handling.

The following techniques will help you to handle paper sensitively:

Make sure your hands are clean. You should wear gloves for added protection. Cotton gloves are often recommended, but they are not always appropriate because they can make it harder to pick up individual pieces of paper. Clean, close-fitting surgical gloves are a good alternative to cotton gloves.

If you must pick up a piece of paper to examine it closely, place it on a rigid support, such as a piece of cardboard, and lift the board. Holding a sheet of paper in your hand may cause it to curl and increase the risk of damage.

If you must carry pieces of paper over a distance, place them horizontally and supported on a rigid support, such as cardboard. It is even better to place the item between rigid supports, because this prevents the paper lifting as you walk.

If paper is already mounted on cardboard, do not simply tuck it under your arm to be carried. It should be supported as described above. This is because many old pieces of paper have been mounted on boards which have become brittle with time. If these boards break, the attached pieces of paper will also break.

If you must lift a flat paper item without a support, hold the sheet of paper with both hands, at opposite edges or at diagonal corners. Lift the sheet, allowing it to droop in the centre with an even curve, but no buckles or kinks.

For extra protection, you can carry paper in folders, Mylar pockets, Copysafe sleeves or polyethylene bags.

Your storage and work areas should have adequate space for laying out works. Before placing items on a work table, it is best to line the surface with sheets of clean paper.

Use pencil when working near paper items. Pencil can be removed from paper, whereas ink can be quite difficult and, in some cases, impossible to remove.

Make copies of paper items that are accessed regularly or that are to be displayed in poor conditions or for a long time. Originals should then be safely stored and accessed only in special circumstances. You can photocopy stable material such as printed documents, but copy the original only once—make any further copies from the photocopy. You should also make photocopies of faxes that are to be kept, then keep the copies on file. Ideally, these photocopies should be made on archival, acid-free paper.

CAUTION:

Fragile material, and items which are extremely light-sensitive, for example early photographs, should not be photocopied in this way. Light-sensitive material or items that are damaged or deteriorated, such as brittle wood-pulp paper items or material with faded inks, can be reproduced, but the work should be done by professionals. Even newspapers and maps can be copied onto better-quality paper using large-format photocopiers. State galleries and museums can suggest places that offer archival reproducing services.

The do's and don'ts of repair and labelling

Inappropriate labelling and repair methods can damage paper. The following guidelines can help to prevent such damage.

Biros, other ink pens and markers should not be used to label paper items. Many of these inks, particularly felt-tip pen inks, can spread and cause unsightly staining.

If you must label a paper item, write in soft pencil—a B pencil is good—on the edge of the back of the paper. Don't press down when writing because you might leave grooves in the paper.

Guidelines for storing and displaying flat paper

Paper clips, even plastic ones, can damage and distort paper. They should not be used for attaching labels, even temporary ones. If you need to place a temporary label on a paper item, write on a piece of paper that is large enough to fold around the whole item.

Never mend pieces of paper with self-adhesive sticky tapes; these cause problems as they deteriorate. At first, the adhesive will become sticky and be easily absorbed into the paper. As the adhesive changes chemically, it begins to yellow and eventually turns a dark orange. At this stage, the adhesive is almost totally insoluble and any stains cannot be removed.

If you have a damaged piece of paper, place it in a protective sleeve or wrapper. This can prevent further damage until you can get advice from a conservator.

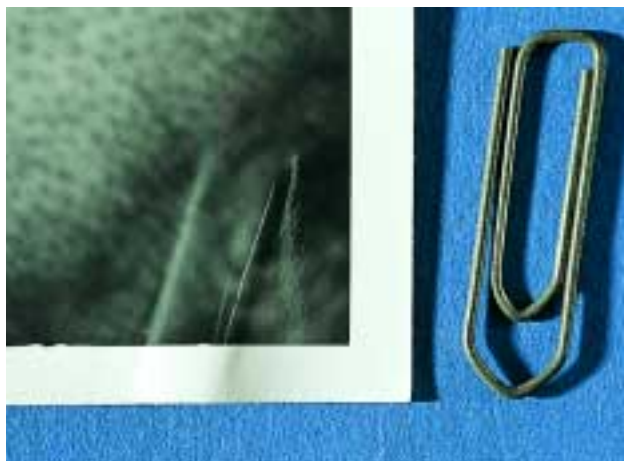

This photograph shows the damage that can be done by leaving paper clips on paper.

Photograph courtesy of Vicki Humphrey



Severe staining usually results when you use sticky tape to repair paper.

Photograph courtesy of Vicki Humphrey

Good storage and display environments can prevent physical damage and help to slow chemical deterioration. This increases the life of paper items. Poor storage and display conditions affect all items in a collection. The effects are not always immediately or dramatically obvious. Paper changes gradually over time; but once changes have occurred they are irreversible or involve complex and costly treatment. The following sections cover storage and display conditions, options, materials and techniques.

In an ideal world, the areas used for the storage and display of flat paper, and indeed the entire building housing a collection, would be environmentally controlled. Air-conditioning would be maintained constantly and monitored, the temperature and relative humidity would be maintained at optimum levels, the air would be filtered, light levels would be controlled and there would be ample space and funding for every item to be appropriately framed or housed.

Unfortunately, few of us are lucky enough to live in such a world. But it is important to be aware of the optimum storage and display conditions for paper; and to work towards achieving them using the resources available, a lot of ingenuity and a little compromise.

Ideal conditions for storing and displaying paper

The following conditions will help to protect your collections of paper.

Keep the temperature constant and moderate. The optimum temperature is 18–22°C. This range accommodates people's comfort, as well as the need for a low storage and display temperature.

Keep the relative humidity as constant as possible—in the range 45–55%. Do not hang or store paper items on outer walls, on walls outside bathrooms or in areas where there might be steam from a kettle or urn.

Keep light to the minimum necessary for the activity. Ideally, paper should be stored in the dark. Light levels in display areas should be as low as possible, and display periods should be limited.

- The recommended lighting level for display of paper items is 50 lux or less.
- The UV content of the light should be no greater than 75 μ W/lm and preferably below 30 μ W/lm.
- All light sources in working and display areas should be filtered for UV radiation.
- Avoid using heat-producing lights and spotlights.

Items need to be fully supported.

Areas should be kept clean and well-ventilated. Dust and other pollutants should be kept to a minimum.

Steps should be taken to protect collections against insect and mould attack.

Good housekeeping procedures should be enforced with regular monitoring of storage and display areas.

For more information

For more information about adverse environmental effects, please see *Damage and Decay*.

General storage guidelines

Wherever possible, the storage site should be in a central area of the building where the effects of climatic fluctuations and extremes will be minimal. That is, away from external walls and not in the basement or the attic.

The storage site should not have any water, drainage or steam pipes, particularly at ceiling level. Leaking pipes can cause a lot of damage.

The storage system used should be reasonably easy to use and should allow easy access. Ease of use and ease of access usually means things will get less damaged during handling. Frustration with a difficult system often leads to damage.

Wherever possible, flat paper items should be stored horizontally in boxes.

Dividers should be placed within storage boxes or filing cabinets. Dividers reduce the movement of items with the storage system and provide additional support to the stored items.

Layers of storage should be provided. This approach gives maximum protection from:

- fluctuations in relative humidity and temperature. This is especially important in areas where the ideal levels of relative humidity and temperature cannot be achieved: the multiple layers of storage act as a buffer zone between the paper items and extreme or fluctuating conditions;
- dust, pollutants and insects; and
- the damaging effects of light.

Wherever possible, each paper item should have its own protective wrapper or enclosure to protect it.

Further layers of protection should be provided. Individually wrapped paper items should be boxed.

Storage and housing systems should be labelled on the outside so items can be located easily without having to search through and inspect every similar item.

For more information

More information on making protective enclosures and storage boxes is given later in this chapter.

CAUTION:

Cleaning materials containing chlorine bleaches or ammonia should not be used near collections of paper.

Naphthalene, insecticides and fungicides are active chemicals which can damage paper, especially in an enclosed storage environment.

Care should also be taken to not stack too many storage boxes on top of each other. This can make access difficult and can result in damage to the collections and in injury.

Materials suitable for the storage and display of paper

Materials which are to be in direct contact with items for any length of time should be free of acids and other impurities which might damage paper. These products are usually marketed as

archival, museum quality, acid-free or permanent materials. They will be referred to as 'archival' materials in this chapter.

Paper, card and board

Archival paper, card and board should:

- have a pH of 7 or above;
- be made from fully bleached, alpha cellulose pulp and sized with an alkaline size;
- be free of lignin, ground wood, metal particles, plasticisers, sulphur, oxidising chemicals and other potentially harmful products; and
- meet stringent strength and permanency specifications.

The highest quality paper products are 100% cotton. They are often referred to as 100% rag.

CAUTION:

Alkaline-buffered products should not be used with some photographic material or with silk-based material.

Plastics

Inert plastics should be free of plasticisers, surface coatings and other harmful chemicals. Polyester films, known as Mylar D or Melinex, polypropylene and polyethylene, are all suitable. Polyester is the superior archival plastic.

Adhesives

Adhesives are used to hinge paper items to their mounts/mats, as well as in the construction of storage enclosures. Adhesives which are water-based, chemically inert and fully reversible can be used in direct contact with paper; for sticking hinges to paper for example. Home-made wheat starch paste and methylcellulose are recommended. Some archival, acid-free gummed paper tapes can also be used.

Adhesives to use if you are making enclosures, photo corners, boxes etc. are:

- 'acid-free' double-sided tape—3M double-sided tape #415; and
- PVA.

These products should never be used directly on your paper item because they are difficult to remove, especially PVA.

Furniture

The materials in storage and display furniture can damage paper. Many materials give out active chemicals which can contribute to the deterioration of paper items. The following list of good and bad materials can help you in selecting storage and display furniture, or the materials to use when making them yourself.

Good	Bad
enamelled metal	chipboard, Customwood, unsealed woods, especially hardwoods
glass	PVA glue
ceramic	uncured paint
inorganic pigments	protein-based glues, for example animal glues
polystyrene	wool
polyester film	felt
cotton	cellulose nitrate
linen	polyurethanes
acrylic paints and varnishes	PVC

Stainless steel, anodised aluminium or metal coated with baked enamel are preferred for storage furniture.

Preparing flat paper for storage

Before you put flat paper items into storage, it is important that you complete the following steps.

Examine them and document their condition. This will help you determine which storage method is most appropriate for the item and whether the item should be displayed. For example, items with a friable medium such as charcoal, or with a fragile paint layer, might need deep window mounts to protect the image surface.

Sort them according to their condition. It is important to separate items which are very acidic, to prevent the migration of acids and impurities into sound paper items.

Check them for mould and/or insect infestation.

For more information

For more information on methods for examining items and assessing their condition, please refer to the chapter on Collection Surveys and Condition Reporting in *Managing Collections*.

Gently brush them with a soft brush to remove surface dust where necessary, but only if the item is stable.

CAUTION:

Do not brush the surface of items with friable or fragile media. Pastel and charcoal drawings, for example, could be badly smudged if brushed.

Unfold creased corners and open out folded items.

Check for material which may damage the item, such as acidic paper or plastic wrappers, rusty paper clips and timber backboards.

Document, label and retain and associated material which may be of importance.

Interleave items with archival tissue or paper where possible.

If you have damaged items, document them, separate them from the collection and seek advice from a conservator.

Housing flat paper

Proper housing is essential to preventive conservation. As already noted, providing an individual item with its own protective enclosure is a very effective way of minimising damage. This serves as a buffer against the environment, as well as offering protection from physical damage and direct handling.

How a collection or individual items from a collection are housed will depend on:

- the type of items;
- the number of items;
- whether they will be heavily used;
- whether they will be displayed or used for research;
- how much money you have to spend;
- how much storage and display space you have; and
- what skills and time you have to do the work.

Flat paper items can be stored in a variety of ways. They can be:

- mounted/matted and framed;
- mounted/matted and placed in Solander boxes;
- encapsulated and placed in a box;
- placed in boxes, drawers and folders, with or without interleaving;
- placed in albums;
- placed in envelopes; and
- slipped into transparent archival sleeves and housed in a binder; or hinged into archival scrapbooks.

Mounting/hinging flat paper

Mounts/mats serve to:

- protect your flat paper items from physical damage;
- discourage direct handling;
- give structural support;
- allow the paper to respond naturally to fluctuations in environmental conditions;
- enhance the appearance of your paper items, and so are widely used to display paper items; and
- buffer against acidity if you use acid-free, alkaline buffered mount board.

The structure of a mount

Standard mounts consist of:

- a window mount with a bevelled window. The bevelled edge prevents shadows falling on the paper item when mounted works are lit for display; and
- a backboard to support the flat paper item.

To give adequate support, especially to heavier papers, both the window and the backboard should be cut from board that is at least four ply.

Acid-free archival boards give the best protection to paper items. Acidic boards are much cheaper; but they will cause damage and will need to be replaced sooner, because they can deteriorate quite rapidly.

The window mount is hinged to the backing board, either down the left side or along the top edge with a continuous strip of gummed, linen tape. The window mount and the backboard should not be stuck together in such a way that makes the item inaccessible.

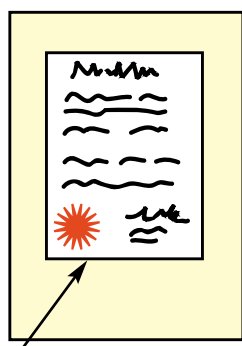
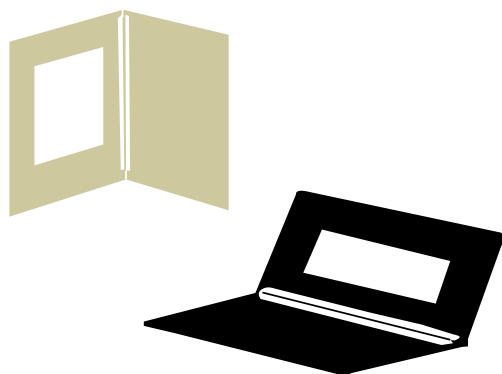

The item is held or "clamped" in place where the window mount overlaps its edges

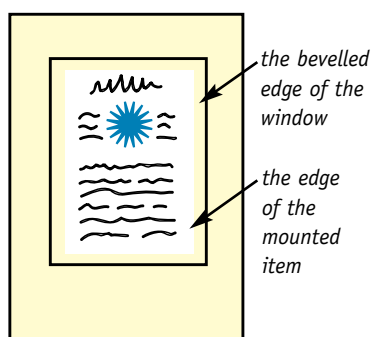

The item appears to float within the window. Float mounting is used where image or text come very close to the edge of the paper and where the edges are decorative etc.

Items can be:

- clamp-mounted: that is with the paper held down where the window mount overlaps the edges; or
- float-mounted: that is with the entire item showing and with a small distance between the edge of the paper and the window.

There are a number of stages involved in mounting/matting a flat paper item. These stages are outlined in the following sections.

Cutting and assembling the window and the backboard

To begin, you cut two pieces of board of equal size. The size of the mount is determined by:

- the size of the item;
- the size of the frame or box you are putting the mounted item into; and
- the width of the margins you want around the window in the window mount section.

Windows are usually cut with the width of the top and side margins equal. The bottom margin is usually slightly weighted visually; that is, it is usually slightly larger than the others. This visually centres the mounted item.

Once cut, the backing board can be put aside while you cut the bevelled-edge window.

Windows are basically quite easy to cut; but you usually won't find mount-cutting easy at your first attempt. Practice, a steady hand and the right equipment are essential for a good result.

Mount-cutting equipment ranges from simple hand-held tools such as mount-cutting knives and the Dexter which are run along a straight edge, to expensive table or wall-mounted machines. Wall-mounted machines should really be considered only if you need to cut lots of mounts over a long period of time.

Instructions for cutting the window are not given here because they vary according to the equipment you have. For more information, consult a conservator.

Once the window and the backboard have been cut, they can be hinged.

- Lay them down flat, side by side. The inside face of each should be facing upwards. Their longest edges, either the top or the left-hand edge of the completed mount, should abut each other.
- Cut a strip of gummed linen tape, just a little shorter than the longest edge. Wet the gum and put the linen tape in place as a hinge. Don't use too much water.

Close the mount and align the backboard and the window, and lightly weight it while it is drying.

Once dry, the mount/mat is complete. It is now ready for the paper item.

When large quantities or complicated mounts are required, it may be more efficient to have mounts cut by a framer; but make sure that you specify archival-quality board if that is what you want. Very few framers use archival-quality board unless they are asked to.

Mounts can be modified in various ways to suit an item. For instance, a sink mount with a deep window would be suitable for an item lined on thick board and a double-sided mount with windows front and back for an item with images on both surfaces.

Hinging and mounting, especially of fragile items, is often better left to conservators or conservation framers, who can be relied on to use archival techniques.

Hinges

It is recommended you attach your flat paper items to their mounts by hinging them to the backboard. The item should not be attached to the reverse side of the window mount, or stuck



A mounted watercolour.

Photograph courtesy of the Ian Potter Art Conservation Service, University of Melbourne

with adhesives or self-adhesive tapes directly to the backing board. These methods of attachment can be very damaging and very expensive to reverse.



This photograph shows clearly that the watercolour is not attached to the back of the window. It is hinged to the backing board.

Photograph courtesy of the Ian Potter Art Conservation Service, University of Melbourne

Hinges are made from high quality archival papers—usually conservation-grade Japanese papers, which are:

- durable, lightweight, long-fibred and extremely strong; and
- available in a range of weights from art supply stores.

The most common types of hinges are the T-hinge or drop hinge for clamp-mounted items, and the V-hinge or fold-under hinge for float-mounted items.

Making hinges

Japanese paper can be water-cut to produce hinges with soft, feathered edges: so avoiding ridges showing on the upper side of the paper item.

To water-cut Japanese paper, place a ruler on the paper parallel with the grain and run a brush dipped in water along the ruler edge. Keep the ruler on the paper and tear the paper along the wet lines to make hinges of the desired size.

The size of the hinges depends on the size of the item; but for small items an oblong hinge of approximately 30 x 15mm is appropriate.

When hinging an item which is to be clamp-mounted, adhere small hinges along the top edge of the paper.

The number of hinges used depends on the size of the item, but one hinge at either end is sufficient for smaller items. More hinges are recommended for larger items and for thick papers. Additional hinges can be required at the bottom of the item, if it is being float-mounted.

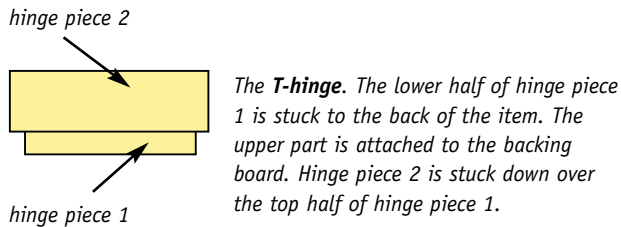

The V-Hinge. One side of the hinge is stuck to the item and one to the backboard.

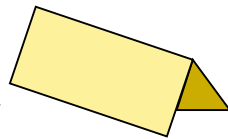

- Flat paper items in study collections are often hinged to sheets of heavy-weight archival paper, which are in turn hinged into mounts to facilitate handling.



One hinge is weighted while it dries, the other is being stuck down to the backing board.

Photograph courtesy of the Ian Potter Art Conservation Service, University of Melbourne

Attaching hinges

- Place the item face-down on a clean surface.
- Brush adhesive onto half the lengthwise side of each hinge. Allow it to almost dry. Place the pasted part of the hinge on the reverse side of the item. The unpasted part of the hinge should extend beyond the edge of the item.
- Cover the hinge with a piece of release paper and rub a bone folder lightly over the area, then press the hinged area under the release paper and a blotter with a small weight until it is dry.
- The item should then be positioned on the backboard in relation to the window, and weighted.
- The other half of the hinge is then brushed with adhesive, allowed to almost dry and then attached to the backing board.
- A second, slightly larger piece of Japanese paper is often stuck over the upper half of the hinge to provide strength, forming a T shape. The hinge is then bone-folded and pressed.
- The adhesive used for hinging and other work on paper items should be water-based and reversible; starch paste or methyl cellulose paste are recommended.

Making starch paste

Starch paste is the adhesive most widely used by paper conservators. Starch paste from various sources—for example, from wheat and rice—has been used for centuries to stick paper to paper and textiles to paper. It is recommended for use with flat paper because of its strength, durability and purity. Aged starch paste does not discolour and remains reversible.

Many commercially available adhesives are starch-based but may also contain preservatives, plasticisers, fillers and other unwanted additives which can damage the paper item. Starch paste does not keep well in its wet state. It should be made fresh and can be covered and stored for two weeks in the refrigerator.

You will need:

- 10 grams or 3.5 level teaspoons of Silver Star laundry starch, which is available from most supermarkets;
- 100ml of water, preferably distilled or deionised;
- a stainless steel double boiler, or Pyrex beaker in a saucepan;
- a stove or hot plate; and
- a wooden spoon.

Method:

- Add about 10ml of the water to the starch and mix to a smooth slurry.
- Add more water if required to produce a smooth paste and leave to soak for about half an hour.
- Heat the remainder of the water in the double boiler.
- Add the starch slurry and cook for 20–30 minutes, stirring constantly.
- Leave to cool.
- If the paste is lumpy, press through a Nylon sieve or some fine cloth for example, terylene.
- The paste can be thinned by adding water and blending.

Alternatives to hinges

A fast but less desirable alternative to Japanese paper hinges and starch paste or methylcellulose are tabs of archival paper tape with a gum adhesive. This is known as archival hinging tape.

Photocorners are an excellent method of attaching paper items to mounts without using adhesives. They can be used:

- if the item is appropriately rigid and stable;
- if there is an adequate margin to hide the corners behind the window mount, and as long as they do not damage the medium; for example, abrade the paint; and
- for holding encapsulated material in mounts or on board for display purposes.

Photocorners should be made from polyester film, for example Mylar, and can be bought or made in a variety of sizes. To make photocorners you will need:

- strips of polyester, 100 or 125 micron Mylar D or Melinex, cut to whatever size is required: for example, for smaller items, a strip measuring 15 x 45mm is appropriate;
- acid-free, double-sided tape 6 mm wide—3M double-sided tape #415 is commonly used;
- scissors; and
- a bone folder.

To make up the photocorner:

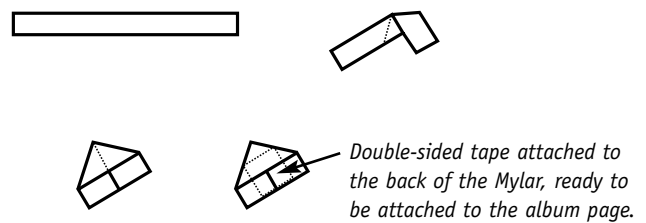

- fold in each end of the strip as shown on the diagram to form a point in the top centre edge of the strip. Make sure the ends butt up to each other;
- use a bone folder to form sharp creases. To avoid scratching the polyester, place a piece of release paper; for example, Glad Bake paper or Reemay, over the photo corner when bone-folding; and
- apply a strip of double-sided tape across the protruding ends of the photo corner.

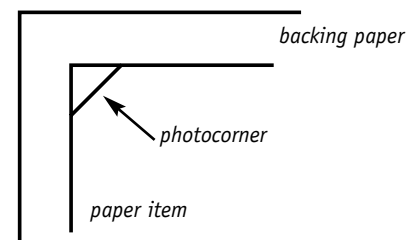

In this way, the photocorner can be stuck down to the backing paper and no adhesive touches the items being mounted.

When using photocorners to attach items to mounts, the item is weighted in place on the backing board and its position checked by closing the window mount. The photocorners are then slipped onto the corners of the item, and the corners attached to the backing board using acid-free, double-sided tape.

Protective enclosures for flat paper

Loose flat paper items benefit substantially from being stored and handled in simple, protective archival enclosures.

There is a large variety of archival enclosures available commercially. They come in a range of

standard sizes and include folders, envelopes and sleeves made from archival card, paper and plastics.

If you need only a small number of enclosures, you can make them cheaply and quickly from readily available materials. If you are doubtful about the archival quality of a ready-made product, you can make the enclosures yourself from archival materials you buy for the purpose.

Making a protective enclosure/folder

To make a simple folder for a single-sheet flat paper item, you will need:

- a large sheet of medium-weight archival paper, such as 160gsm archive cartridge or lightweight card;
- a cutting mat, preferably with a gridded surface;
- a sharp cutting knife;
- a metal ruler;
- a bone folder; and
- a sharp pencil and an eraser.

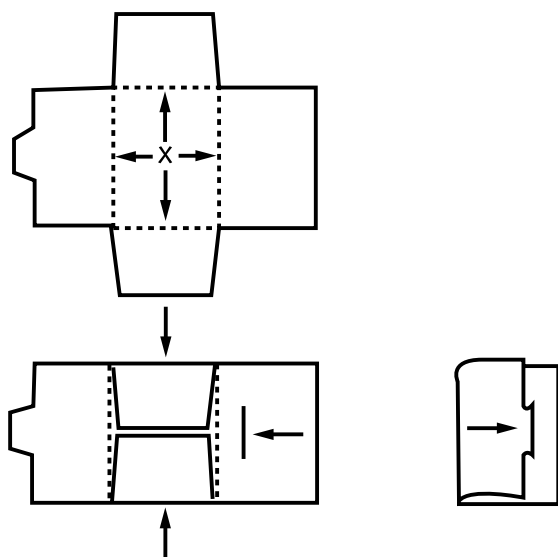

To construct the folder:

- use the diagram provided to rule up and cut out the folder plan onto the paper or card. The dimensions of x—shown on the diagram—should equal the dimensions of the item to be housed plus about 3mm on each side;

- run the bone folder down the fold lines against the ruler edge, then fold the paper or card. Use the bone folder to make smooth, sharp folds;
- erase the pencil marks and construct the folder;
- determine the correct location of the slit for the closing tab and make the incision; and
- label the folder in pencil.

Some useful hints:

- use a piece of release paper—Glad Bake paper or Reemay—when bone-folding to avoid leaving a shine on the card or scratching the polyester; and
- for extra support, the base of the protective enclosure could be fitted with a piece of acid-free board.

Encapsulating flat paper

An encapsulation is a transparent envelope that is sealed around an item on all sides, leaving a small opening at each corner for ventilation. Encapsulation is widely used as an easily reversible method of protecting flat paper items for storage, display and general handling. It is a way of holding torn items together without repair. Encapsulation is most often used for archive material and maps.



An encapsulation.

Photograph courtesy of the Ian Potter Art Conservation Service, University of Melbourne

The transparent material used for encapsulation is Mylar or Melinex, an inert, durable polyester film. Encapsulation involves sandwiching the paper item between two sheets of the polyester film. The paper item is held in place by the electrostatic charges between the film sheets. The margins of the film are then sealed either with acid-free

double-sided tape, or by using a special polyester welding machine. The encapsulation can be sealed on all four sides, or be left open on one or two sides. Partial encapsulation is a good alternative when regular and easy access is needed.

Materials that are unsuitable for encapsulation include:

- items that crumble easily such as pastel, chalk, charcoal, pencil and gouache. The electrostatic charge on the polyester can pull the material away from the paper; and
- mouldy or insect-infested items, and some severely acidic or damaged material. The encapsulation can seal in harmful substances creating a poor microclimate.

If an item needs to be seen only from one side and is weak or acidic, a sheet of acid-free, alkaline-buffered paper or card can be enclosed behind the item. For stronger support of single-sided material, substitute the lower polyester sheet with acid-free board.

Encapsulated material can be mounted, boxed or placed in folders or drawers.

If you are planning to encapsulate a paper item, it is important to ensure that the item is suitable for encapsulation. Ask a conservator if you are unsure of the suitability of an item for encapsulation.

CAUTION:

Do not allow polyester to come into direct contact with fragile materials or with materials which crumble easily, such as charcoal and pastel.

To encapsulate an item you will need:

- polyester film, Mylar or Melinex. The thickness of the film will depend on the size of the item to be encapsulated; 75 micron or 100 micron is generally used, and sometimes a heavier gauge for large material;
- a cutting mat, preferably with a gridded surface, or use some graph paper on top of the cutting surface;
- double-sided tape, acid-free 6mm wide—3M double-sided tape #415 is commonly used;
- a sharp cutting knife and small scissors;

- small weights;
- a metal ruler;
- an anti-static cloth or soft cloth;
- tweezers; and
- clean work surfaces and clean hands.

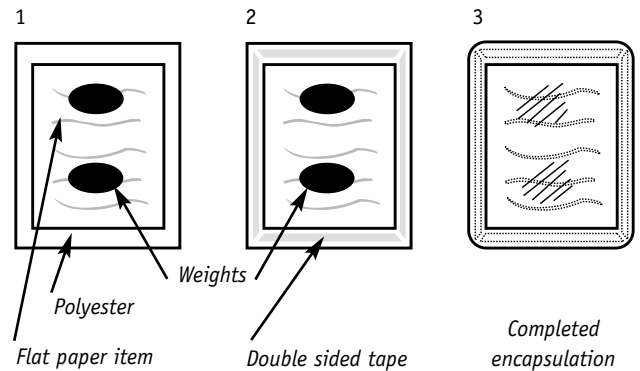

To encapsulate paper:

- remove any surface dirt with a soft brush. Remove pins or staples and unfold bent corners;
- cut two pieces of polyester film at least 2cm larger than the item on all sides. For example, if the item is 300 x 210mm, cut the polyester to measure 340 x 250mm;
- place one sheet of polyester on the cutting mat and wipe away any dust. Centre the item on the polyester, lining it up using the grid on the mat. Secure the item with one or two small weights;
- carefully stick the double-sided tape to the polyester film down each side of the item, leaving a 3–5mm space between the tape and the item. Use tweezers to hold the tape and align it by using the object and the grid as a guide. Cut the tape with scissors, leaving a small space at each corner;
- remove the weight and place the second piece of polyester on top of the item, checking for dust first. Re-weight the whole package;
- lifting the top polyester sheet at one edge, peel the cover paper from one strip of tape at a time, smoothing down the polyester with your hand or a soft cloth to get rid of distortions and to ensure a good seal; and

- using the ruler and the knife, trim the edges of the encapsulation about 3mm outside the tape lines. The sharp corners of the polyester can be rounded using scissors.



Double-sided tape being applied to the edges of a polyester sheet, during encapsulation of a paper item.

Photograph courtesy of the Ian Potter Art Conservation Service, University of Melbourne

Some useful hints for encapsulating paper

Keep the double-sided tape in a plastic bag when you are not using it, to avoid dust collecting on the edges of the tape. This happens very easily and the dirt is visible in the encapsulation. Bagged tape can be stored well in a domestic refrigerator.

A soft cloth or lens tissue very slightly dampened with water can be used as an anti-static cloth for cleaning the polyester.

If the item needs to be seen only from one side and is weak or acidic, a sheet of acid-free, alkaline-buffered paper or card can be enclosed behind the item. For stronger support of single-sided material, substitute the lower polyester sheet with acid-free board.

Don't wear fluffy jumpers when you are encapsulating!

To laminate or not?

Encapsulation should be differentiated from lamination. Lamination adheres the paper item to an adhesive film and a plastic layer on both sides.

Lamination is sometimes promoted as a way to preserve your paper items. But once a paper item is laminated, it is virtually impossible to remove

the lamination material without damage to the item and without the use of quite strong chemicals.

Lamination serves as a protective device for cheap posters and material which can be easily replaced; but it is not reversible and definitely not recommended for valued flat paper items.

A reversible alternative is to place it in a Mylar sleeve.

Storage boxes for flat paper

Boxes allow paper items to be stored flat, while also providing effective protection against mechanical damage, light, dust, and extremes and rapid changes in temperature and relative humidity. For the best protection, the boxes should be made from archival materials.

Boxes are important if you are providing layers of storage for your collections. Layers of storage mean layers of protection.

Loose paper items can be interleaved with archival tissue or paper and stored directly in archival boxes. Items that have been encapsulated or placed in enclosures can also be boxed. Ideally, when storing collections of items they should be placed in uniform-sized mounts and enclosures that fit neatly into boxes. This limits movement within the box and minimises damage.

The Solander box is the highest quality box which is commonly used for storing flat paper. It is very



Solander boxes are sturdy and very protective. Be careful if you are lifting large Solander boxes, containing a number of items as they can be quite heavy.

Photograph courtesy of the Ian Potter Art Conservation Service, University of Melbourne



The lid of the Solander box closes down over the base—like a clam-shell.

Photograph courtesy of the Ian Potter Art Conservation Service, University of Melbourne

sturdy and has a shallow clam-shell design with a hinged lid that opens out flat and closes firmly.

Cardboard and polypropylene boxes in various sizes and designs are available commercially. Boxes can be ordered to special sizes, but this may be costly for a small order. Simple, medium-strength boxes can be custom-made for storing flat paper items.

Making a storage box

To make a strong, inexpensive box with a double thickness of board on the base and a triple thickness on the top, you will need:

- a sheet of archival, single-wall, corrugated, box-making board such as Archivart Multi-use board;
- a cutting mat preferably with a gridded surface;
- a sharp cutting knife;

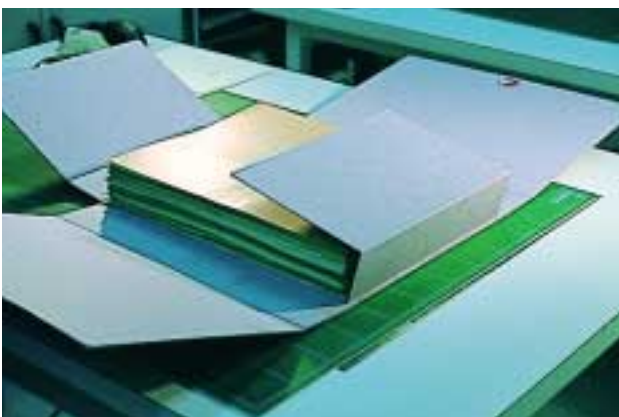

A home-made storage box.

Photograph courtesy of the Ian Potter Art Conservation Service, University of Melbourne

- PVA adhesive, preferably acid-free;
- boards for weights;
- a large metal ruler;
- a bone folder;
- a pencil and eraser; and
- a fastening device of some kind. Ty-tite file fasteners, consisting of a cord which wraps around a piece of cardboard and which are attached with rivets are especially effective.

Putting the box together

Use the diagram provided to rule up and cut out the first piece. The measurements should allow for:

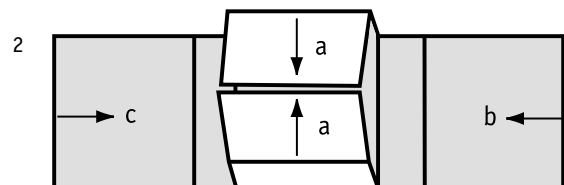
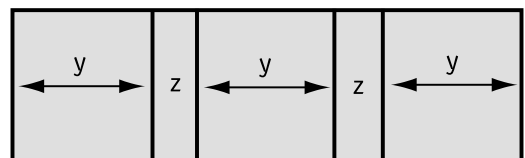
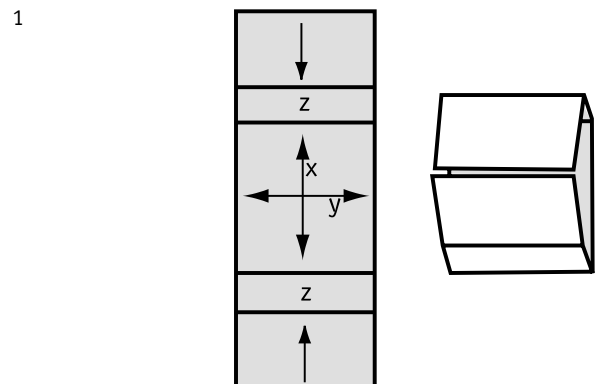

a–c indicates the order in which the flaps should be folded around the item.

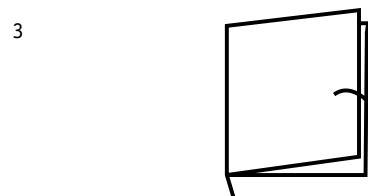

- the base, which is the same height and width as the items to be boxed plus 3mm;
- the sides of the box, which should be equal to the depth of the items to be stored, stacked one on top of the other plus 3mm; and
- the top of the box—in two pieces, each half the height of the base.

Run the bone folder down the fold lines against a ruler edge to start the creases, then fold the board up against the ruler edge. The two outer flaps should meet over the centre of the item to make an open-sided wrap.

Cut out the strip for the second part of the box, allowing a little extra in the overall width, which can be trimmed later. The height of the strip will be the same as for the base; but the width of each panel will differ, to allow for the thickness of the walls.

Align the folded first piece on the far-left side of the second strip, and mark the first fold line in pencil on the second strip. Make the fold line as above. Work across the second strip from left to right, gradually wrapping the first piece inside the second, marking and folding the board as you go, to ensure a snug fit. Trim off any excess in the width of the second piece when you have completed the box.

Erase any pencil marks. Stick the centre panel of the first piece inside the centre panel of the second piece with acid-free PVA. Open out flat, weight down and allow it to dry.

The completed box can be secured in a variety of ways including Ty-tite file fasteners, cotton tape or straps joined with Velcro tabs.

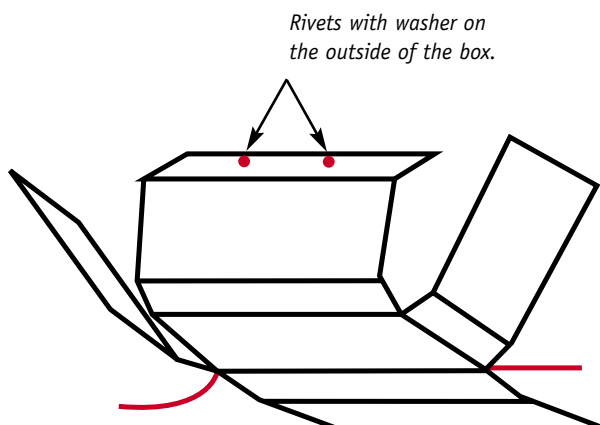

A closed storage box, showing the fastener.

Photograph courtesy of the Ian Potter Art Conservation Service, University of Melbourne

Displaying flat paper

Framing is used to display works of art on paper and many other types of flat paper items.

Unframed materials can be displayed in a number of ways including:

- in display cases;
- in their mounts. If the mounted items are not in display cases, their surface can be protected by placing slip-sheets of polyester under the window mount;
- in their encapsulations;
- on mount board. The items can be held firmly in place on the board, with photocorners or with strips of Mylar across each corner;

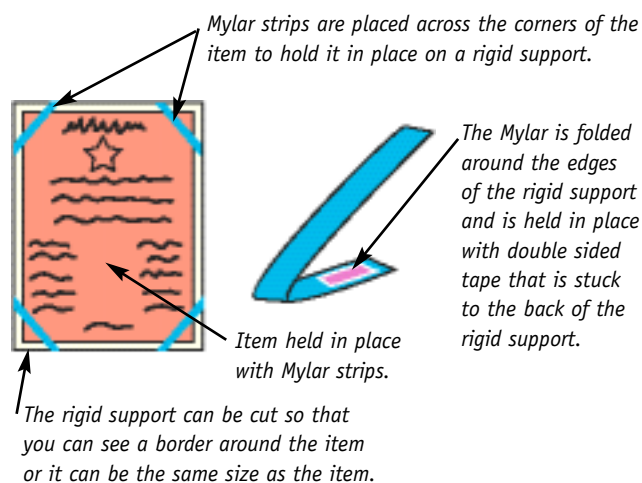

- on mount board and covered completely with Mylar. The Mylar can be attached to the board with double-side tape, either on the front or on the back of the mount board; and

- mounted and/or enclosed material can be held vertically onto display boards using acrylic clips or strips of Mylar across each corner. Never pin through an item or its housing.

CAUTION:

Items that are particularly vulnerable to light need to be protected. They can be covered by black-out cloths when not being viewed.



The black-out cloth needs to be lifted only when the work is being looked at.

Photograph courtesy of the Ian Potter Art Conservation Service, University of Melbourne

Framing flat paper items

Conservation framing provides excellent protection for flat paper items against mechanical damage, dust, acids and the atmosphere. The frame forms a closed but not air-tight housing, allowing a slow interchange of air to take place but at the same time buffering the framed material against rapid atmospheric changes.

Framing is a very effective way of both displaying and storing flat paper items. But archival-quality framing is not cheap, and framed material takes up space; so paper items are often framed for exhibition, then unframed and returned to storage boxes.

Apart from the more valuable or popular items in the collection and works with their own frames, the items which benefit most from permanent framing are those which would suffer most from being left unframed—fragile or deteriorated items, works with friable media, and oversize works.

For more information

For more information on oversize works, please see Paper Items with Special Needs later in this chapter

Poor-quality framing can do immense damage to paper items. It is therefore absolutely vital to ensure that items are framed to conservation standards.

Cross-section of a framed flat paper item

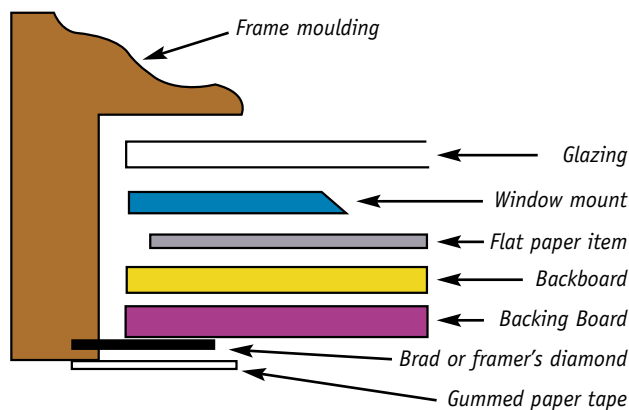

The major requirements for the correct framing of flat paper items are:

- the frame should be sturdy and its rebate should be deep enough to completely house the glass or acrylic glazing, the mounted item and a backing board. The rebate is the groove at the back of the frame;
- the item should always be separated from contact with the glazing by a window mount or by spacers;
- as far as possible, all materials used in the framing package should be archival. If you have to retain original material which is not archival, for example, mounts and backing boards you should insert a barrier of polyester or heavy-weight archival paper between the non-archival material and the item;
- because of the electrostatic charges that build up on acrylic sheet, glass should be used when framing any items which crumble easily. For example, pastel, charcoal, chalk or cracked paint, which is common with gouache; and
- the hanging devices should be sturdy. The frame should hang from two points on the wall, rather than hanging by a wire from one single point. D-rings hung from screws or hooks on the wall are suitable.

In special cases, the frame can be sealed to further isolate the item. Air-tight framing, or creating a sealed package within the frame, is sometimes used for travelling exhibitions or special items in a collection. This method reduces the flow of air, thereby reducing the effect of rapid environmental changes on the item. But it can also cause problems by creating an undesirable microclimate in the frame. Air-tight framing should only be undertaken by, or in collaboration with, a conservator.

If framed works are on extended display, they should be spaced away from the wall using small corks or plugs, to allow air circulation.

Glazing

When selecting glazing for a frame, it is important to note that:

- Acrylic sheet, Perspex, Plexiglas and polycarbonate sheet are light, unbreakable and can include UV absorbers. However, they cannot be used with fragile media susceptible to electrostatic charges; they are also easily scratched, and are more expensive than glass.
- Glass is more rigid. Glass treated to reduce reflected glare is available. If items are transported behind glass, the surface of the glazing should be gridded with masking tape: to reduce damage to the item should the glass break. Old picture frame glass can be more fragile than new glass, and it may be worth replacing it with acrylic sheet if the item is travelling.

The backing board

The backing board should be sturdy, reasonably lightweight and preferably archival. Archival corrugated boards made from paper or polypropylene, for example, Multi-Use Board, Corflute or Foam Cor Board are suitable.

If the backing board is not archival, for example, oil-tempered hardboard, an archival isolating layer should be used to separate it from the mount.

The backing board should be sealed with gummed paper or linen tape, to keep out dust.

Paper items with special needs

Oversize Flat Paper Material

Oversize flat paper items such as posters, maps, plans, wallpaper and large works of art can be difficult to store, handle and display. They are often neglected and are especially prone to mechanical damage when cared for inappropriately.

Wherever possible, oversize items should be kept flat.

Items should not overhang shelves or protrude into aisles.

Mounting and framing should utilise lightweight, archival materials. For example, Perspex instead of glass is ideal; but this is often impractical for space and cost reasons. Extra hinges may be needed to support the weight of the object and keep it flatter.

Avoid lining with cloth and dry-mounting oversize material.

Steel plan chests with large, shallow drawers are used most often for the storage of unframed, oversize items. Archival map-storage boxes can also be used.

Encapsulation or partial encapsulation is often a good alternative for oversize items with stable media.

Simple enclosures for oversize items can be made with a board support and a polyester upper. The items can be displayed and studied in these enclosures.

If possible, loose material in drawers or boxes should at least be interleaved or provided with support sheets of archival paper.

Oversize items should only be rolled as a last resort. The item should be rolled face-out around a large-diameter tube which is acid-free. For example, polypropylene or archival board, or isolated with polyester or heavy-weight archival paper. The whole package should then be wrapped in archival paper, labelled clearly and stored horizontally where it can be supported over its full length.

Newspapers

Newspapers create special problems in any collection. Large collections of newspapers are copied onto some other format, for example, microfilm, and the originals are often vacuum-wrapped and put away for long-term storage. Photocopying may be an option if there is not a large quantity of material. Store newspapers in a sound, acid-free environment, laid flat in polypropylene bags or archival boxes; restrict access. Find out where microfilmed versions are held and encourage people to use them rather than the original.

Papyrus and Parchment

Papyrus and parchment are two non-paper supports which may appear in your collection.

Papyrus

Papyrus is made from the crushed stems of the papyrus plant. It is much closer in character to paper than parchment.

Because of the presence of lignin and other impurities, it is highly susceptible to deterioration. Papyrus is often extremely brittle and, therefore, vulnerable to mechanical damage.

Talk to a conservator about storing and displaying papyrus items.

Parchment

Parchment is made from the untanned skins of animals such as calves, sheep and goats. Vellum is an especially high grade of parchment. It has been used throughout the history of civilisation to create documents, illuminated manuscripts and works of art.

It is extremely sensitive to moisture and will distort if subjected to high humidity levels. An environment of 45-55% relative humidity is ideal. Parchment naturally has some degree of distortion, but severe distortions can cause damage.

Methods of keeping parchment flat, such as sandwiching between glass or adhering to a backboard, are inappropriate.

Parchment can be stored and exhibited in mounts in the same way as paper items; but deeper mounts are recommended: to allow for movement and to offer extra protection. Polyester strips or corners can be used to hold parchment to the backboard.

More complicated mounting procedures and any repair work should be left to a conservator.



An illuminated manuscript on vellum, mounted for display.

Photograph courtesy of the Ian Potter Art Conservation Service, University of Melbourne

For more information

Vellum and parchment are also discussed in the chapter on Books in this volume and in the chapter on Leather in *Caring for Cultural Material 2*

Some miscellaneous information

Copying flat paper material

Material which is accessed regularly, required for long-term display or displayed inappropriately, for example, in areas with high light levels, should be copied.

The originals can then remain safely in storage and need be accessed only in special circumstances.

Photocopying stable material such as printed documents is an option. But only one copy of the original should be taken; and any further copies should be made from the photocopy.

Photocopies should preferably be made on archival, acid-free paper.

Thermal paper faxes which need to be kept should be photocopied and the photocopies filed.

Fragile material and items which are extremely light-sensitive, for example, early pieces of paper, should not be copied in this way.

Material which is damaged or deteriorated, for example, brittle wood-pulp paper items, material with faded inks and light-sensitive material, can be reproduced; but this should be done by professionals.

Even newspapers and maps can be copied onto better-quality paper on large-format photocopiers. State libraries, galleries and museums can suggest places which offer archival copying services.

Historic evidence accompanying paper items

Many paper items may come into your collection in their original folder, in a frame or mounted on a card with inscriptions.

Often these materials accompanying the items are dirty, deteriorating and not of particularly good quality. However, they often provide you with valuable information about the items and so should not be discarded.

If these accompanying materials are in very poor condition, they should be lightly brushed clean, wrapped and clearly labelled, then stored separately from the items.

Summary of conditions for storage and display		
	Storage	Display
Temperature	18–22°C	18–22°C
Relative Humidity	45–55%RH	45–55%RH
Brightness of the Light	For all paper dark storage is preferred. If the items are being used by researchers, the light should be kept as low as possible and the periods of exposure to light should be kept to the absolute minimum.	Ideally should be no higher than 50 lux.
UV Content of Light	Dark storage is preferred but if light is present, UV content should be no greater than 75 μW/lm, and preferably below 30 μW/lm.	No greater than 75μW/lm, preferably below 30μW/lm.

Paper in Australia's Climatic Zones

The climatic zones outlined below are broad categories—conditions may vary within these categories depending on the state of repair of your building and whether the building is air conditioned or not.

Arid

This climate is generally very dry, however, in arid areas, it is often very hot during the day and very cold at night. This wide fluctuation in temperature is matched by wide fluctuations in relative humidity, eg from 75%—20%RH in a day.

When caring for paper items in arid areas, it is important to note that:

- insects can still survive;
- paper items can become dry and brittle; and
- items can be put under stress by the movement that occurs as the paper dries out and contracts.

Remember that:

- the layer system of storage, for example items in folders in boxes in cupboards, will buffer items against rapid changes. This multi-layered system also protects items against dust and grit problems which often occur in arid environments;
- you must be aware of condensation forming inside plastic storage materials due to temperature fluctuations. This could lead to irreversible damage; and
- regular inspections of storage and display areas are important to detect any problems which are developing.

Note: If your paper collections have been stored in an arid environment for a considerable period and are stable—**do not** try to alter the environment to meet the recommended ideal conditions. This could do more harm than good, the emphasis should be on long term stability.

Temperate

A temperate climate is considered a moderate climate, however, temperate climates tend to have a greater range of temperatures than tropical climates and may include extreme climatic variations.

Bear in mind that:

- it is probably easier to achieve an environment close to the recommended ideal in a temperate climate. However, it is unlikely that you will be able to maintain an even environment without the help of constant sophisticated air-conditioning equipment;
- the layer system of storage eg. items in folders in boxes in cupboards, will buffer items against any rapid changes; and
- regular inspections of storage and display areas are important to detect any problems which are developing.

Note: If your paper collections have been stored in a temperate environment for a considerable period and are stable—**do not** try to alter the environment to meet the recommended ideal conditions. This could do more harm than good, the emphasis should be on long term stability.

Tropical

These climates are characterised by heavy rainfall, high humidity and high temperatures.

When caring for a paper items in high humidity, it is important to note that:

- high temperatures and light levels increase rates of deterioration;
- insects and moulds thrive and reproduce rapidly;
- glues and other adhesives used to attach items are likely to swell or soften;
- paper clips and other clasps made of metal are likely to corrode;
- cockling and distortions of the paper support are more likely to occur, creating stress to paint layers and other media; and
- paper can be damaged if it cockles severely while it is stuck down unevenly or excessively to a board.

Remember that:

- ventilation is all important—it is vital to consider air flow when planning storage and display areas;
- when encapsulating paper items, it is necessary to ensure that the paper does not have a high moisture content as this will cause moisture to be trapped in the encapsulation;
- the layer system of storage. For example items in folders in boxes in cupboards, will buffer items, against rapid changes and extremes; and
- regular inspections of storage and display areas are important to detect any problems which are developing.

Note: If your paper collections have been stored in a tropical environment for a considerable period and are stable—**do not** try to alter the environment to meet the recommended ideal conditions. This could do more harm than good, the emphasis should be on long term stability.

MORE ABOUT PAPER

Cellulose fibres and paper quality

Paper is made from cellulose fibres which are derived from plant sources. Alpha cellulose is very high-quality cellulose which contains no additives or impurities of any kind. It consists of long, ribbon-like molecules made up of smaller glucose units. The glucose units are formed from atoms of carbon, hydrogen and oxygen. These molecules are held together side-to-side by hydrogen bonding to form 'sheets', which in turn are stacked together in tightly packed layers to form 'microfibrils'. The microfibrils group themselves in bundles; and groups of these bundles form the paper fibre.

All paper up until the 19th century was hand-made, primarily from cotton and linen rags and hemp, which produced papers of great strength and permanence. As the need for paper developed and the demand for raw materials outstripped supply, ground wood was introduced as a paper-making fibre. This resulted in the mass-production of papers which were weaker and less permanent.

Industry has developed ways of refining wood-based paper to raise their quality and longevity by isolating the cellulose in the wood from the resinous substances which make the paper acidic, that is the lignins. Today, acid-free wood-based papers are available—these papers contain a high percentage of alpha cellulose and have a permanency which is equal to cotton-based papers.

Acidity and Alkalinity

Acids in paper contribute significantly to its deterioration. They attack and break apart the bonds which hold the cellulose chains, the microfibrils, and the fibres together.

Where do the acids come from?

Acids are by-products of the breakdown of impurities such as lignin, and of the cellulose fibres themselves.

Alum-rosin sizing is a major cause of acid deterioration in paper. Rosin, or pine resin, is applied to paper to make it less absorbent, that is, to size it. Because rosin does not attach readily to paper, papermakers' alum, also known as aluminium sulphate, is used to form a link between the paper and the rosin. Rosin breaks down to produce acids, and papermakers' alum produces sulphuric acid.

Atmospheric gases and pollutants, such as sulphur dioxide which forms sulphuric acid, can attack paper.

Acids can migrate from adjacent acidic materials.

Acidity, alkalinity and pH

The strength of acidity or alkalinity of any substance is given as a measure of pH. The pH value is a measure of the availability of free hydrogen ions.

The pH scale runs from 0 to 14. pH 0 is very acidic and pH 14 is very alkaline or basic. pH 7 is a neutral value: neither acid nor alkaline.

Papers which are buffered with an alkaline substance such as calcium carbonate usually have a pH measurement of about 8.

Paper and paper-based products suitable for use in storage and display of flat paper should be acid-free; but in order to be meaningful, the pH value of a paper must be used in conjunction with other selected specifications for archival papers.

A pH testing pen can be useful for spot-testing the acidity or alkalinity of storage materials but this is not a foolproof method.

CAUTION:

Do not use a pH testing pen to test items in your collection because it will leave a strong stain in the paper.

If you have a problem relating to the care of flat paper, contact a conservator. Conservators can offer advice and practical solutions.

For further reading

CCI Notes, n.d. Canadian Conservation Institute, Ottawa, Canada. These notes are updated annually.

Clapp, A.F. 1987, *Curatorial Care of Works of Art on Paper*, 4th edn, Nick Lyons Books, New York.

Dolloff, F.W. & Perkinson, R.L. 1971, *How to Care for Works of Art on Paper*, Museum of Fine Arts, Boston.

Ellis, M.H. 1987, *The Care of Prints and Drawings*, The American Association for State and Local History (AASLH), Nashville.

Thompson, J.M.A. 1992, *Manual of Curatorship: A Guide to Museum Practice*, 2nd edn, Butterworth-Heinemann, London.

Self-evaluation quiz

Question 1.

What two major activities are central to the preventive care of flat paper?

- a) correct restoration treatments;
- b) restoration of frames;
- c) correct storage and display.

Question 2.

The highest quality archival papers are those which are:

- a) acid-free;
- b) high in cellulose and free from acids and impurities;
- c) buffered to raise the pH.

Question 3.

Major factors which harm paper are:

- a) low light levels;
- b) migration of impurities from poor-quality storage and display materials;
- c) housing items in unframed mounts.

Question 4.

What is meant by foxing in paper?

- a) brown areas of discolouration caused by light;
- b) invisible signs of weakness;
- c) small brown spots usually caused by mould.

Question 5.

What is not a recommended environmental condition for paper?

- a) temperatures of between 18°C and 22°C;
- b) relative humidity of over 65 % RH;
- c) illumination levels of 50 lux or less.

Question 6.

What material is not suitable for use in storage and display of paper?

- a) inert plastics such as polyester and polypropylene;
- b) masking tape;
- c) wheat starch paste.

Question 7.

Before flat paper items are placed in storage they should be:

- a) fumigated;
- b) examined for damage and deterioration and documented if necessary;
- c) restored.

Question 8.

When a paper item is correctly mounted it should be hinged to:

- a) the backboard of the mount;
- b) the reverse side of the window;
- c) the backing board of the frame.

Question 9.

Encapsulations for flat paper are made using:

- a) polyvinyl chloride;
- b) polyester;
- c) acid-free paper.

Question 10.

When framing flat paper items it is important to:

- a) space them away from the glazing;
- b) use acrylic sheet such as Perspex for pastel and charcoal drawings;
- c) use tinted glass.

Answers to self-evaluation quiz

Question 1.

- c). Restoration treatments are interventive rather than preventive.

Question 2.

- b). Paper and board can be acid-free or buffered and still contain impurities.

Question 3.

- b). Low light levels are recommended for paper. Mounting is a suitable protective method, with or without a frame.

Question 4.

- c). Foxing is a type of mould which develops due to a combination of high humidity and temperature coupled with acids or impurities.

Question 5.

- b). When relative humidity is over 65 % RH, the conditions are more suitable for mould growth.

Question 6.

- b). Masking tape is not an archival product. It can stain and weaken paper considerably and is very difficult to remove.

Question 7.

- b). Items only require fumigation if there is evidence or a high possibility of mould or insect infestation. A conservator should be consulted. Restoration may not be required or appropriate.

Question 8.

- a). Paper items should never be hinged to the window mount, nor should the backing board double as a backboard.

Question 9.

- b). Polyvinyl chloride is a low-grade plastic which discolours and degrades. Encapsulations are made of transparent material, so paper is not appropriate.

Question 10.

- a). Paper should be spaced away, to avoid condensation and media-transfer occurring. Acrylic sheet should never be used to glaze items with friable or fragile media such as pastel and charcoal drawings. The term 'tinted glass' does not refer to UV-filtering glass.

BOOKS

Objectives	page 33
Introduction to the care and repair of books	page 33
Parts of the books	page 33
What are the most common types of damage	page 34
Book structure, materials and damage to books	page 36
Wear and tear of books	page 39
Common causes of damage	page 40
The do's and don'ts of handling books	page 40
The do's and don't of repair and labelling	page 41
Storing and displaying books	page 42
The best materials for storage and display of books	page 44
Storage enclosures for books	page 44
Easy do-it-yourself storage enclosures for books	page 45
How does light affect books on display?	page 48
Supporting books when they are on display	page 49
Summary of conditions for storage and display	page 50
Books in Australians climatic zones	page 51
Book maintenance	page 52
Some miscellaneous advise	page 54
MORE ABOUT BOOKS	
A brief history of books	page 55
Types of bindings	page 56
Materials commonly found in books	page 59
Paper repair	page 61
For further reading	page 63
Self-evaluation quiz	page 64
Answers to self-evaluation quiz	page 65

Objectives

At the end of this chapter you should:

- have an understanding of the main factors that contribute to the deterioration of books;
- have practical knowledge about how to store and display books so that damage is minimised;
- have a basic knowledge and some practical skills so that you can make boxes, and do basic repairs in the best and safest manner, and use appropriate materials to preserve books in your collections;
- understand the need for ongoing maintenance and management of books—to ensure access to them—while at the same time minimising the risk of damage; and
- have a basic knowledge of book structures and the range of materials which go to make up books.

Introduction to the care and repair of books

Books have been with us for centuries. In early years, they were rare and owned usually by wealthy people or the Church. With the invention of moveable type in 1440, text could be mass-produced. This inevitably led to wider distribution and greater demand for books. But they were not produced immediately on the massive scale with which we are now familiar.

Over time, increased demand for books led to a shift from books being hand-made by craftspeople to a greater mechanisation of production. Mechanisation and the availability of cheaper materials have meant that we can meet the massive demand for books; but books are no longer what they used to be, and we have to deal with the consequences of these changes in book production.

Books, old or new, cheap or valuable, are still treasured. People love books—for the information they hold, as objects, as gifts and as collectors' items—and it is important that you are able to take steps to care for the books in your collections.



Hand-coloured 19th century children's book.
Photograph courtesy of Vicki Humphrey

Parts of the book

There are a number of unique terms used to describe the parts of a book. It is useful to identify the main parts of books by these terms, because they are used throughout this section.

The following diagrams give a simple overview of the main parts of books.

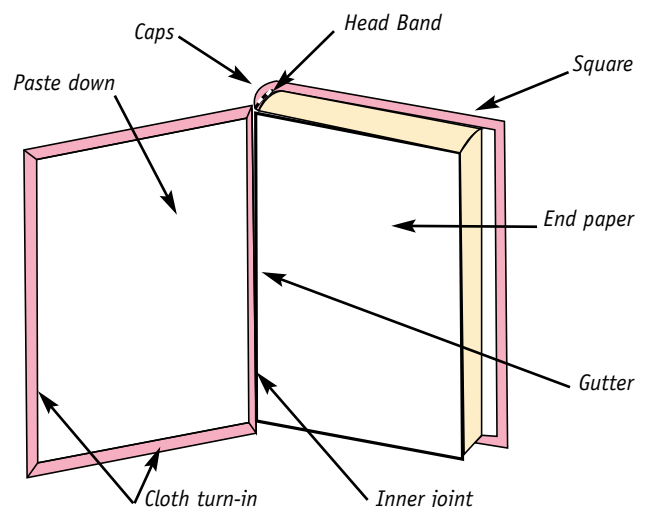
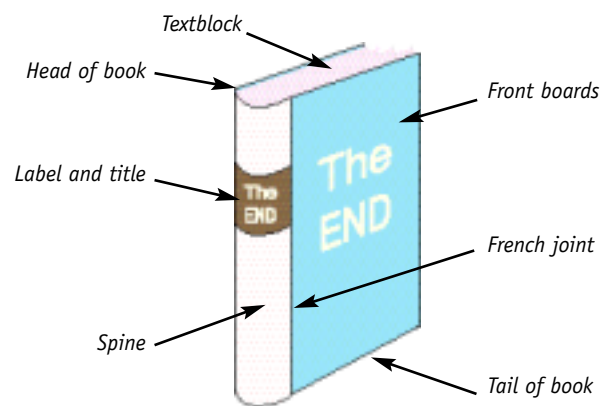

The textblock is generally made up of:

- sections or gatherings. These are folded sheets of paper grouped together. The individual sections are joined to others by sewing through the folds. This is the traditional, textblock form; and

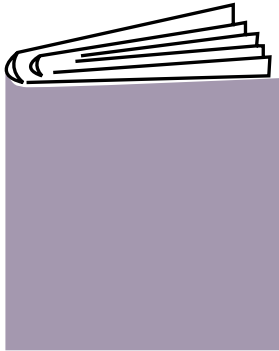

- single sheets of paper glued, sewn or glued and sewn together. This is a modern binding and is more likely to fall apart.

What are the most common types of damage?

Books are vulnerable to physical damage and to the damage caused by chemical deterioration of their components.

Physical damage is very obvious and includes problems such as:

- dog-eared pages;
- tears to pages;
- loss of pages—especially in modern books made up of single sheets attached by sewing or gluing;
- broken joints and detached covers;
- scuffing, wearing and losses to the bookcloth, leather or paper covers;
- insect attack;
- wear and tear from excessive or careless use; and
- distortions caused by fluctuations and extremes of relative humidity and temperature in storage and display environments.



Dog-eared corners are at the head and tail of this 18th century book. There is other damage to the centre of the pages.

Photograph courtesy of Vicki Humphrey



The back cover of this 19th century paper-covered book is damaged, stained and soiled.

Photograph courtesy of Vicki Humphrey



This book has lost its front cover and spine, the back cover remains in place but is poorly attached.

Photograph courtesy of Vicki Humphrey



This dictionary is only a few years old, but because the text block is made up of single sheets glued at the spine, the book has fallen apart.

Photograph courtesy of Vicki Humphrey



The leather covers of this 17th century book are badly worn and scuffed.

Photograph courtesy of Vicki Humphrey

Damage caused by chemical deterioration includes:

- the textblock and binding materials fading, becoming discoloured and becoming brittle. This can be caused by exposure to UV radiation and high lighting levels and the ageing of the materials in the book and the materials with which the book is in contact;
- mould growth—mould digests the materials on which it grows; and
- damage from pollutants. This is a problem particularly with leather bindings when they came into contact with sulfur dioxide pollution. This produces a condition called red-rot.

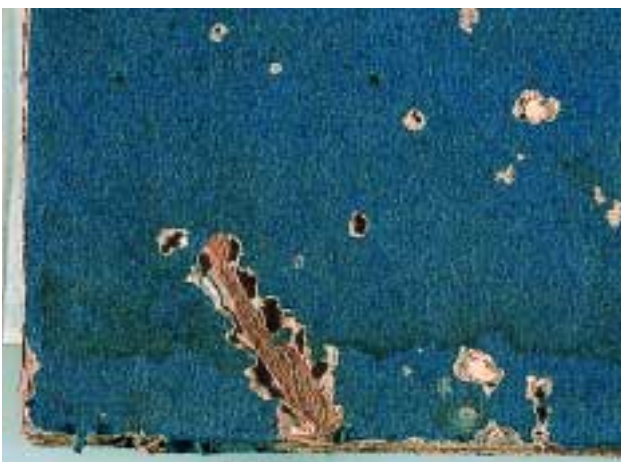

Insects feasted on this book, eating through covers and text blocks.

Photograph courtesy of Artlab Australia, reproduced with permission of the State Library of South Australia



This 19th century book has been stored on a bookshelf. Its spine has faded as it has been exposed to light, while the front and backboards have been protected by the other books on the shelf.

Photograph courtesy of Vicki Humphrey



The covering material has dried out in low relative humidity, pulling the board out of shape.

Photograph courtesy of Artlab Australia, reproduced with permission of the State Library of South Australia



This modern book is only 14 years old and already the paper is beginning to discolour because of the lignin in the paper.

Photograph courtesy of Vicki Humphrey

The book as a structure



This book has suffered severe mould damage, not just to the surface of the paper shown but also to many layers beneath.

Photograph courtesy of the State Library of New South Wales



This leather binding deteriorated after exposure to sulphur dioxide pollutants in the atmosphere.

Photograph courtesy of Artlab Australia, reproduced with permission of the History Trust of South Australia.

For more information

For more information about adverse environmental effects, please see *Damage and Decay*.

Book structure, materials and damage to books

The life-span of books will be determined to a large degree by:

- their structure and their ability to open well in use; and
- the materials from which they are made.

It is important, therefore, to have some information about structure and materials so that you can provide appropriate care.

All books are three-dimensional structures that are required to move. For this reason they should be strong, flexible and durable. Unfortunately this is not always the case. For example, many modern books, particularly text books and reference books, don't have adequate sewing and binding structures to support the weight of their textblocks. This is made worse when the books are stored upright in shelves. As a result, the textblocks sag and the spines tend to collapse. The sewing also breaks down and the sections within the book begin to come loose.

Some older books bound in the flexible style are very difficult to open fully. The term flexible in this case refers to the spine, which ideally remains flexible and curves when the book is opened allowing the pages to throw open fully. In this style, the covering material, usually leather, is glued tight to the spine of the textblock. Unfortunately, excessive lining and over-enthusiastic use of glue have often led to very inflexible structures. This style of binding is also not suited to textblocks with very stiff paper.

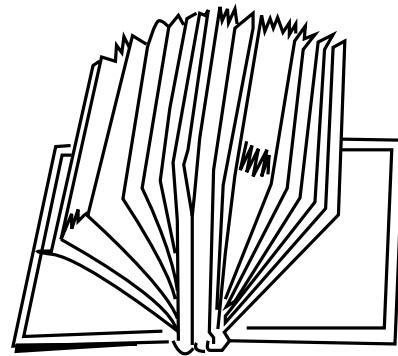

Books are designed to be moving structures, so that they can be opened and read. The evolution of book design did not anticipate the development of flat-bed photocopiers. Many books are being subjected to uses that their structures cannot withstand repeatedly.

CAUTION:

When photocopying a book on a flat-bed photocopier, do not force it open and press it flat to the glass. You may end up with a photocopy—but you could destroy the book in the process.

Deterioration of materials in books

There are a large range of materials used in book production. They are all in very close contact, and will affect each other. If some of these materials are poor quality and begin to deteriorate, they are highly likely to adversely affect the other materials in the book.

Paper is very vulnerable to damage and deterioration if stored in poor conditions, or if made from poor quality ingredients. Many papers, particularly modern papers, become acidic over time. Often the acids develop in the paper from the breakdown of the materials in the paper. These acids attack the cellulose fibres which make up paper, shortening the fibres and making the paper more brittle.



This paper is a poor-quality paper that contains lignin. The paper has discoloured severely, is brittle and breaks easily.

Photograph courtesy of Artlab Australia

Lignin, from untreated wood pulp, breaks down and produces acids when it is exposed to UV radiation. These acids discolour paper and make it brittle.

Some sizing agents break down to produce acids. Sizes are applied to paper to stop inks soaking into it, as they would into blotting paper.

Chlorine bleaches used to whiten paper can remain chemically active in paper for a considerable time. Chlorine can combine with moisture from the air to produce hydrochloric acid.

Impurities in the water used during papermaking can damage paper. Copper and iron are particularly damaging.

Paper is a food source for insects, rodents and moulds.



Insect damage can be extreme as seen on this severely damaged book.

Photograph courtesy of Artlab Australia, reproduced with permission of the State Library of South Australia

Boards on hardcover books, and the thin cardboard covers on paperbacks, are made in a similar way to paper and they often have many of the same problems as paper. They can become acidic and these acids can migrate into the textblock.

Strawboard is an exception. Lime is used in its manufacture, so the board is quite alkaline. It has a distinctive, brown-yellow colour which when wet readily stains anything it contacts. This stain can often be mistaken for discolouration caused by acids.

The interaction of adhesives, covering materials and boards in conditions where relative humidity fluctuates can cause severe distortion of the boards. This leaves the textblock vulnerable to damage.

Some inks and pigments can damage paper. For example:

- iron gall inks—which were used extensively for manuscripts—contain acids and iron, which both attack paper;
- verdigris—basic copper acetate—was used in many Islamic books, particularly in borders around text. In many cases, this pigment has eaten into the paper; and the text it surrounded can easily drop out.



The acids from the iron gall ink on these pages have attacked the paper, leaving it very brittle. The paper is also very discoloured.

Photograph courtesy of State Library of New South Wales



The animal glue around the left and lower edge of this watercolour is very discoloured, and on the left hand edge it has become brittle and broken up.

Photograph courtesy of Artlab Australia



The green border around the text has been painted with verdigris—a copper pigment. The damage you see in this photograph is very typical of older Islamic books where verdigris is used extensively as a border.

Photograph courtesy of Artlab Australia, reproduced with permission of the State Library of South Australia



This vellum page from a 13th century manuscript shows extensive cockling.

Photograph courtesy of the State Library of New South Wales

Many inks and pigments are affected by UV radiation, high lighting levels and extremes of temperature and relative humidity; this results in inks fading and discolouring, and sometimes becoming blurry.

Animal glue is essentially a poor-quality, impure gelatine. It is a rich food source for insects and moulds—cockroaches enjoy a good munch on animal glue. Animal glue breaks down when it ages. It often becomes discoloured and darkens, which can cause staining. It can also become very brittle. When this happens, it crumbles and falls away.

Vellum and parchment are untanned animal skins. They are both very moisture-sensitive. In high relative humidity conditions the skins absorb moisture and can distort and cockle. As the relative humidity decreases, the skins dry and become less flexible, and distortions and creases can become set into the skin.

Vellum and parchment can be attacked by insects and mould. Unlike paper—because lime is used in their manufacture—they are not susceptible to attack by acids.

The leathers traditionally used for bookbinding are vegetable tanned leathers and are very susceptible to:

- insect and mould attack;
- fading when exposed to light and UV radiation;
- drying out and losing their flexibility; and

- red rot. Leathers with red rot have a rusty-red colour, and leave fine deposits of red powder on shelves, tables and hands. When the chemicals in leather start to breakdown, the leather becomes powdery. Sulphur dioxide—a common atmospheric pollutant—combines with moisture from the atmosphere to form sulphuric acid, which breaks down the leather fibres. The leather loses its flexibility, splits and crumbles forming a fine red powder.

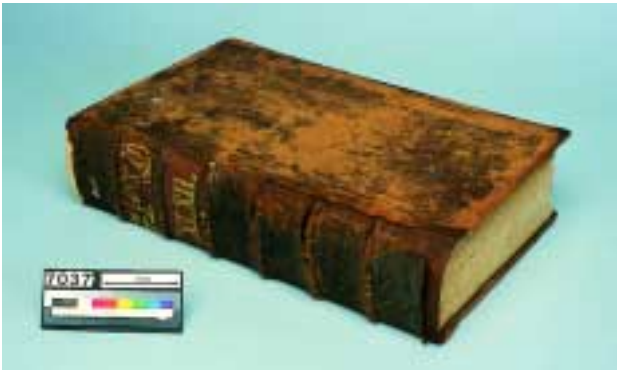

This leather binding has deteriorated under the action of sulphur dioxide pollutants in the atmosphere. This leather has a condition called 'red-rot'.

Photograph courtesy of Artlab Australia reproduced with permission of the History Trust of South Australia

Many bookcloths are susceptible to damage from mould and insect attack, and to fading caused by excessive light levels and exposure to UV radiation.

Examine your collection. How many books have faded spines, yet the front and back covers are closer to their original colours because they have been protected by the other books on the shelves? Many bookcloths can also be discoloured and damaged by water.



The lighter areas on this bookcloth are areas of water damage.

Photograph courtesy of Vicki Humphrey

For more information

For more information about leather, vellum and parchment, please see the chapter on Leather in *Caring for Cultural Material 2*. For more information about adverse environmental and chemical factors, please see *Damage and Decay*.

Wear and tear of books

Apart from the deterioration of the materials which make up books, one of the greatest enemies of books is wear and tear. Wear and tear is an apt name for the deterioration caused by excessive, inappropriate or careless use, as well as for the results of this deterioration.

The fact that there are so many books, and that they are so freely and easily available, means that we tend to take them for granted. We don't handle them correctly and we don't care for them properly. If we want them to last we have to change all this.

What contributes to wear and tear? Among other things:

- leaving books open face-down to keep your place. This weakens and can eventually break the book structure;
- folding the corners of pages to mark your place;
- careless photocopying on a flat-bed photocopier, particularly where the print is very close to the spine and the book does not open out well;
- careless shelving of books. Books which are meant to be stored upright on shelves are often seen leaning to one side;



Books are often allowed to lean to the side, which can damage them.

Photograph courtesy of Artlab Australia

- overcrowded shelves;
- removing books from shelves by pulling strongly at the top of the spine;
- handling books with dirty hands, or eating and drinking while reading;
- pressing flowers in books;
- writing in books;
- dropping books; and
- using staples, pins, metal paper clips and rubber bands on or in books.

In most cases, the effects of wear and tear are not seen immediately, and so little is done. It is important to know how to store, handle and display books correctly—to minimise the damage which can result from wear and tear.

Common causes of damage

All the most common types of damage are caused by:

- poor handling;
- poor storage methods;
- inappropriate display methods;
- wear and tear from repeated use;
- chemical changes in the materials which make up books; and
- chemical changes caused by chemicals which are present in materials in contact with books, or which are present as pollutants in the atmosphere.

Much of the common damage to books can be prevented by care and pre-planning your handling, storage and display of books.

The following sections will outline practical steps you can take to minimise this type of damage.

The do's and don'ts of handling books

Care and commonsense in handling books will help to prevent damage.

When removing a book from the shelf don't pull it by the top of the spine because you can cause a great deal of damage this way.

The correct way to take a book from a shelf is to push the books on either side of it further into the shelf and hold the book firmly, with your hand around the spine and your fingers on one cover and your thumb on the other. For this reason, it is wise to leave some space between your books and the back of the shelf when you first set them up on a shelf.



This is the wrong way to remove a book from a shelf.
Photograph courtesy of Artlab Australia



This book shows clearly the damage that can occur when books are removed from shelves by pulling at the top of the spine.
Photograph courtesy of Vicki Humphrey

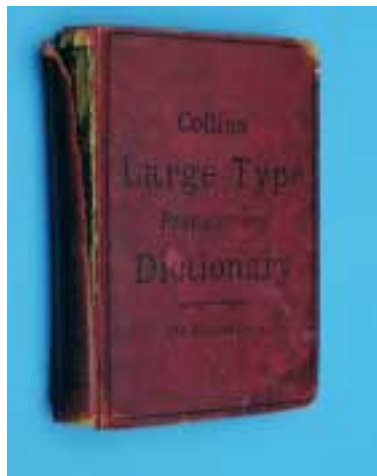

The joint of this book has split from the top of the book, indicating that it was probably removed from the shelf in the wrong way for many years.
Photograph courtesy of Vicki Humphrey



The correct way to remove a book from a shelf.
Photograph courtesy of Artlab Australia



Give your book adequate support when removing it from a shelf.
Photograph courtesy of Artlab Australia

Make sure your hands are clean when you handle books. Otherwise you can leave dirty marks on the bindings and the pages. Wearing gloves provides added protection—cotton gloves are recommended—but they are not always appropriate because they can make it much harder to turn the pages. Clean, close-fitting surgical gloves are a good alternative to cotton gloves. But cotton gloves should be worn when handling books with gold leaf decorations on the covers or on the foredge of the book.

Books should be opened gently: the spine and the sewing can be broken if the book is forced open. If you're using a book which can't open flat, give it some support so that you don't strain its structure. Some book supports are shown in the section on supporting books when they are on display; but you can also improvise—by using another smaller book or, perhaps, the jumper you are carrying with you in case it gets cold.

When opening new or newly bound books, don't open them from the centre. Start from the front and then the back, and open them gradually, section by section, until you reach the middle. This eases them open gradually and flexes the new structure. Opening them at the middle and forcing them to open flat can break the structure.

It is always best to turn pages slowly and with care. It is very easy to tear paper if you are flicking through the pages quickly. Don't lick your fingers to turn pages—the moisture can set dirt into the paper. You can also transfer dirt and germs from the paper to your mouth. If the book has been fumigated against insects or mould, you can put yourself at risk.

Don't try to carry lots of books at once. You could hurt yourself and if you drop the books you will damage them. If you are carrying valuable books, put them in a sturdy box.

The covers of books can be severely disfigured by abrasion and scratching. This is especially noticeable with very smooth, calf-leather bindings. Don't stack valuable or delicate books, or carry them in such a way that they will rub against each other.

The do's and don'ts of repair and labelling

Inappropriate labelling and repair methods can damage and devalue books. The following guidelines may help to prevent such damage.

If books are damaged, be aware that some repairs can cause further damage. For this reason it is recommended that you do not use sticky tapes of any kind.

These tapes go through a number of stages when they deteriorate. Firstly, the adhesive becomes very sticky and will be absorbed easily into paper, bookcloths and leather. In the next stage the adhesive changes chemically, and begins to yellow and eventually turns a dark orange. At this stage, the adhesive is almost totally insoluble and the stains cannot be removed. Once the adhesive becomes insoluble, the tape usually falls away, so the repair has failed and you still have the damage. In addition to the original damages, the paper is now badly stained as well.



This damaged dust jacket was repaired with sticky tape which has discoloured and stained the paper.

Photograph courtesy of Vicki Humphrey

Don't attempt to mend torn pages or damaged covers, unless you have good-quality materials and are confident that the methods you use will not cause damage in the future. Talk to a conservator if you're not certain that you're doing the right thing, or if you want information about training courses.

If the boards have come off one of your books, don't try to reattach them with sticky tape. It is better to place the book, with its cover, in a wrapper or a phase box until it can be repaired properly. The book can still be used, but it is protected properly until it is treated.

Ball-point pens or other ink pens and markers should not be used to label books. Many of these inks, particularly felt tip pen inks, can spread and cause unsightly staining. If you need to handwrite a label, it is best to use a permanent ink—such as Indian ink.

If you use rubber stamps or embossing stamps regularly for labelling your books, be careful about



This photograph shows the damage that can be done by leaving paper clips on paper for a length of time.

Photograph courtesy of Vicki Humphrey

where you place the stamp. Many books have important images and printed plates, and these can be ruined if a stamp is placed over the image or over part of it.

Paper clips, even plastic ones, can damage and distort paper. They should not be used for attaching labels or marking your place. Metal paper clips rust over time and stain paper.

Storing and displaying books

Adverse storage and display conditions affect all items in a collection. The effects are not always dramatically obvious. Changes tend to occur gradually over a long period of time; but once the changes have occurred they are often irreversible, or involve complex and costly treatment.

Good storage and display environments prevent physical damage and help slow down chemical deterioration, greatly increasing the life of books. The following sections outline:

- the ideal conditions for the storage and display of books;
- general storage guidelines;
- the best materials to use for the storage and display of books;
- enclosures for books—some easy do-it-yourself storage enclosures;
- the effects that light can have on books on display;
- lighting hints; and
- supporting books when they are on display.

Ideal conditions for storing and displaying books

Books are made up of many different materials. The sensitivity of particular materials and the value of the books—be it monetary, sentimental or other value—will determine your approach to providing a controlled environment for your collection.

Ideally, books should be stored in an environment where:

Temperature is constant and moderate—in the range 18–22°C. Because books are often stored in areas where people use them, 18°C may be considered too low for comfort. In this case, 20–24°C would be acceptable but higher temperatures than this are not recommended.

Relative humidity is in the range 45–55%. This is important for books. If the relative humidity is too high, mould and insect activity are highly likely to increase because the glues are very attractive to them. If the relative humidity is too low, the glues dry out and lose their flexibility. Because paper, leathers, bookcloths and glues react at different rates to changes in relative humidity—and because fluctuations in relative humidity can cause bindings to distort—it should be kept as stable as possible.

Light is kept to the minimum necessary for the activity. Ideally, books should be stored in the dark. Light is really necessary only when they are being selected from the shelves. This is not always practical because books are often stored in the same area in which they are used; and in libraries, selection of books from shelves can continue over many hours. It is necessary to have light for display, but the lighting levels for display don't need to be as high as the lighting levels in a reading room.

Books fall into different categories of light-sensitivity, depending on the materials from which they are made, their value and their condition. Most collections of general-use books would be considered to be non-sensitive to light. Despite this, if you want them to last, you should try to keep their exposure to bright light down to a minimum.

All books should be protected from exposure to daylight. The UV content of the light should be less than 30µW/lm and no more than 75µW/lm.

If the books are particularly sensitive to light—for example, books with watercolours, dyed leathers, some older dyed bookcloths and rare or valuable books with paper covers—the brightness of the light should be 50 lux or less.

If the books are moderately sensitive to light, the brightness of the light should be 250 lux or less.

Steps must also be taken to protect books from dust and pollutants—especially if your collection contains leather-bound books.

For more information

For more information about adverse environmental effects, please see *Damage and Decay*.

General storage guidelines

Careful consideration should be given to the storage site and the storage system. In ideal conditions, a good storage system in an appropriate storage site provides added protection for your collection. If the available facilities or the local climate make it difficult for you to achieve ideal conditions, then the selection of the storage site and the maintenance of a good storage system are even more critical in preventing damage to the collections.

The following notes are guidelines for selecting storage sites, and outline the principles to be followed to protect your collections in storage.

Wherever possible, the storage site should be in a central area of the building, where it is buffered from the extremes of climatic fluctuations which can occur near external walls or in basements and attics. The storage site should not contain any water, drain or steam pipes, particularly at ceiling level. Leaking pipes can cause a lot of damage. Basements should also be avoided because of the risk of flooding.

Don't store books in sheds. The storage site and the shelving used for your books should allow reasonable ventilation. Also remember to inspect and clean book shelves regularly. These two simple measures help reduce the risk of insect and mould infestation and help greatly in controlling any outbreaks.

Give books adequate support and try to reduce the physical stresses which can damage them. Many books are very badly shelved. This eventually distorts the binding and can damage the sewing structure, which causes books to fall apart. Don't allow books to flop to the side on their shelves. Bookends or book shoes should be provided to keep books upright. Book shoes also support the textblock.

Store large volumes flat rather than upright. Most large volumes have heavy textblocks, and not all of them have adequate binding structures to support them. Flat storage prevents the weight of the textblock from collapsing the spine. If several heavy books are to be stored horizontally, they



How not to store your books.

Photograph courtesy of Artlab Australia

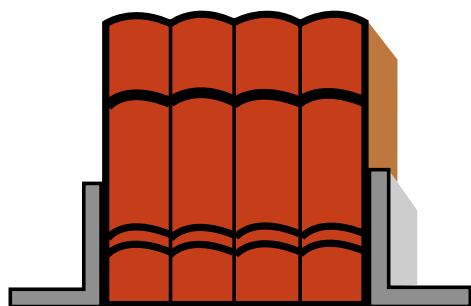

Make sure you support your books and keep them upright on the shelves.

should not be stacked too high. This makes handling awkward and can cause damage. Try to place an empty table or shelf nearby—the books on the top of the stack can be put there if you are trying to remove those at the bottom.

Provide easy access to books—ease of access contributes greatly to the care of books. Difficult access often leads to awkward handling as people try to lift too much weight at one time, risking injury to themselves and damaging the books.

The best materials for storage and display of books

Books can be affected by other materials in their immediate environment. The following list of good and bad materials—from a preservation viewpoint—can help you select your storage and display furniture, or the materials to use when making them yourself.

GOOD	BAD
acrylic paints and varnishes	uncured paint
cotton	wool
linen	felt
inorganic pigments	PVA glue
polystyrene	PVC
polyester film	cellulose nitrate
ceramic	polyurethanes
glass	protein based glues, for example, animal glue
enamelled metal	chipboard, unsealed woods—especially hardwoods—Customwood

Storage enclosures for books

People using books are less hasty and take better care if they see that you are taking steps to protect your books.

Boxes and wrappers provide excellent protection for books. They protect against:

- light and UV radiation;
- dirt and dust;
- disasters; and
- people.

Many rare and valuable books are stored in purpose made Clamshell boxes. When these are well made, using archival-quality materials, they are one of the best methods for storing individual books.

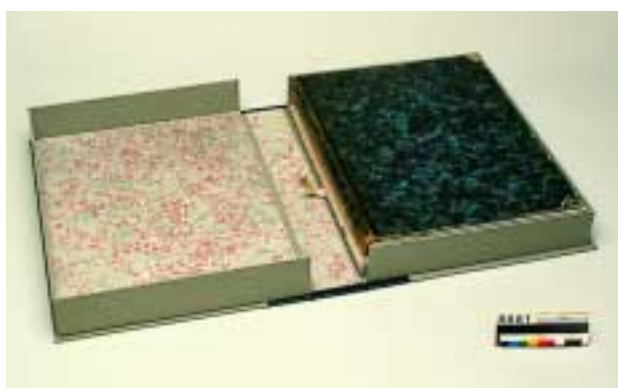

Clamshell box containing a book. The book is sitting in the base of the box on the right. The lid on the left closes over the top of the base.

Photograph courtesy of Artlab Australia

They are handmade and relatively expensive. If you wish to buy this type of storage box, contact a conservator about having boxes made up or about learning to make them. Clamshell boxes are complicated to make—in some cases even for those who have made them before—so we have not included instructions.

A number of ready-made archival-quality boxes are suitable for storing books.



A selection of archival boxes for book storage—available from suppliers of conservation materials.

Photograph courtesy of the State Library of New South Wales

If you cannot get a box to fit your book exactly, buy one that is a bit big and pad out the excess space with acid-free tissue, to prevent the book moving about too much. Don't try and force a book into a box that is too small for it. Alternatively, you can make your own storage enclosures. Instructions for some easy storage boxes and wrappers follow.

Easy do-it-yourself storage enclosures for books

Phase boxes

These boxes are called phase boxes because they are used in libraries in phased conservation programs. When damaged books are identified but cannot be fully treated straight away, they are placed in a phase box for protection—phase 1—until they are programmed for treatment—phase 2.

Phase boxes are usually made from folding box board.

To make a phase box:

- Measure up two pieces of folding box board. The measurements for these pieces have to relate to the dimensions of the book indicated in the diagram below. The measurements for the first piece should allow for:
- the base, (1) on the diagram below, which is the same as the height and width of the book, with a couple of extra millimetres on each dimension to ensure the fit is not too tight;

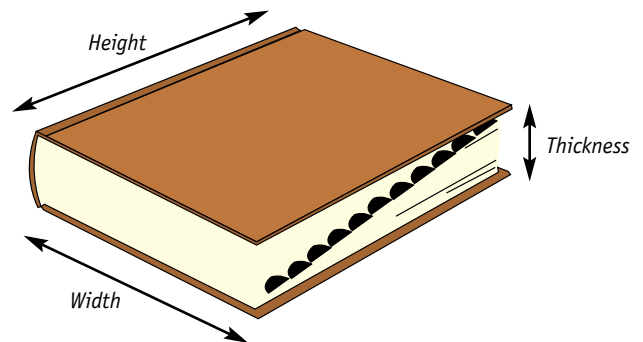

- the sides of the box (2) which are the same size as the thickness of the book, plus twice the thickness of the board you are using—this extra allowance is for folding;
- flaps (3) which should be the same size as the base, minus 3mm from the height of the book; and
- an additional flap (4) which is the height of the book and no more than the thickness of the book: this last flap is the place where the rivets and washers for fastening the box are placed.

The first piece

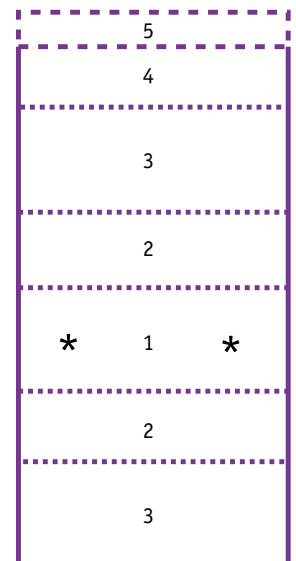

If the book is very thin—less than 3mm—you need to add an additional flap (5). This flap should be 2–5cm wide.

To cut out the first piece, cut along the solid lines indicated in the diagram.

Fold the board along the dotted lines indicated in the diagram. Because folding box board is quite thick, you may need to score both sides of the board with a bone folder, letter opener or the blunt edge of a knife before folding. Folding box board can have quite sharp corners—you may want to round the corners with a corner rounder, knife or scissors.

The measurements for the second section should allow for:

- the base, (1a) on the diagram below. In this case it is the height of the book plus 2–4mm by the width of the book, plus 2–4mm;
- the sides of the box (2a). In this case the sides of the box should measure the same as the sides of the box given for the first piece plus twice the thickness of the board being used. Here you are adding an extra allowance, so that these sides can be slightly larger than the sides on the first piece so they can fold over the flaps of the first piece; and
- the flaps (3a) should be the same size as the base except that the width should be the width of the book minus 3mm.

The second piece

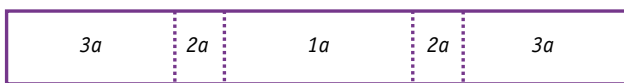

To cut and fold the second piece, follow the procedures outlined for the first section.

To construct the box:

- make two holes in the base of the first section shown on the first diagram by *1*;
- thread some fishing line through this. When the box is folded, the fishing line should be long enough to wrap around the washers that are placed on flap 4 of the first piece;

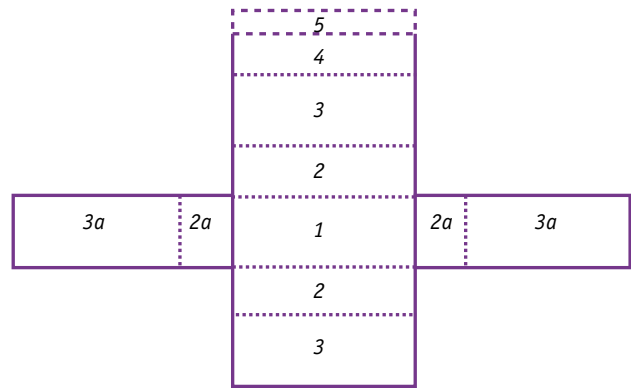

- stick the first piece to the second piece using a strong adhesive such as polyvinyl acetate—PVA. The base (1) of the first piece should be stuck on top of the base of the second piece (1a), making the second piece of folding box board the outside board;
- allow the adhesive to dry under weights—this prevents the boards warping;
- punch holes in flap 4 of the first piece; and
- cut two circles of folding box board to use as washers. Punch holes in these and using rivets or folding paper fasteners, attach the washers to the outside of the flap.

Now your phase box is complete and you can fold the box, place your book inside the box and fasten it by winding the fishing line around the washers.

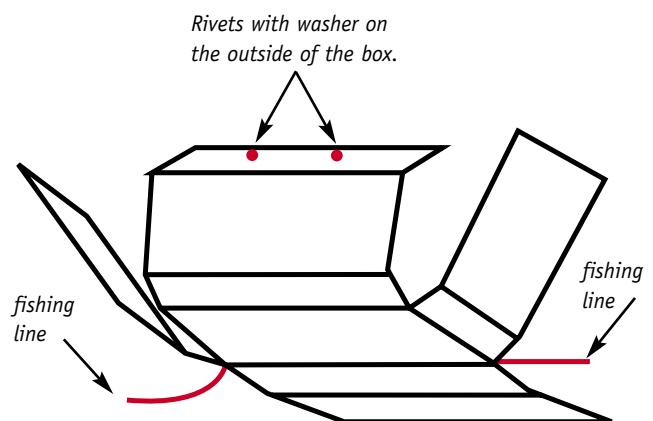

A simple book wrapper

Simple wrappers for books can be made from a laminate of good-quality paper and bookcloth. This is prepared by sticking the paper—dampened slightly—to the bookcloth, using a mixture of acid-free PVA and starch paste. The PVA provides an instant stick, while the starch paste gives you a little bit of slip, in case the paper is not positioned correctly on the bookcloth and you need to slide it into position. The laminate should be lightly pressed while drying, and be fully dry before you start to make the wrapper. Drying can take a couple of days. You may need practice in making this laminate, because the paper and bookcloth can be difficult to handle when they are wet with adhesive. Lightweight, archival-quality board is the easier material to use.

For more information

A recipe for starch paste is given in More About Books later in this chapter

CAUTION:

PVA is not used in conservation treatments. It should not be used directly on the book leathers or the textblock, because it is not reversible. As PVA dries, a chemical reaction takes place and the adhesive film which is formed is not soluble in water.

The best tools to use to make the wrapper are a Stanley knife or similar, a metal ruler and a bone folder or letter opener.

To make the wrapper:

- mark out the required dimensions on the material—using pencil;
- the base of the wrapper should be slightly bigger than the book, to allow it to fold without distorting or damaging the book;
- after the base is marked out, you have to mark out the thickness of the book. Again allow a few millimetres more than the actual thickness. The thickness is shown on each flap between the dotted lines;
- the side flaps are then marked out. They should be slightly shorter than the base, and tapered from the base to the outside edge;

Slit cut to insert tab

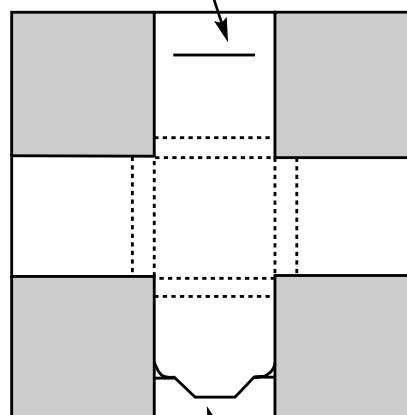

tab cut out—rounded corners

- once it is marked out, the wrapper can be cut. The shaded areas on the diagram are cut away and discarded;
- once cutting is complete, the wrapper can be folded. It is easier to fold the board and paper/bookcloth laminate if you run a bone folder, letter opener or the blunt edge of a knife along the fold line first. The dotted lines indicate where the wrapper is folded;



To score the wrapper material for easier folding, run a bone folder—shown in the picture—letter opener or the blunt edge of a knife along a metal ruler which has been placed on the line of the fold.

Photograph courtesy of Artlab Australia

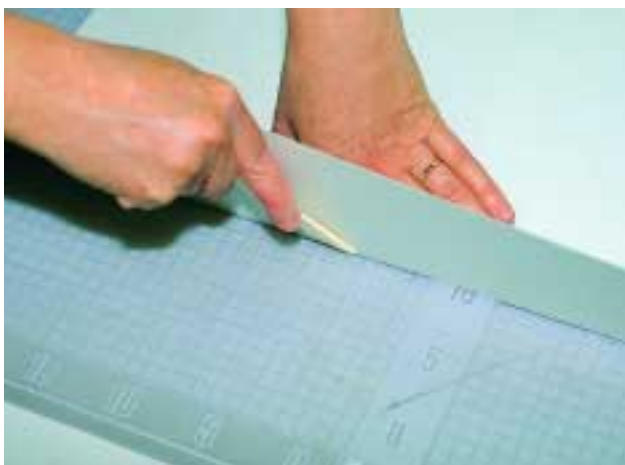

Folding the wrapper using a bone folder and steel ruler.

Photograph courtesy of Artlab Australia



A selection of wrappers for books.

Photograph courtesy of Vicki Humphrey

- if you want to make a tab that will fit into a slot in the wrapper to keep the wrapper closed around your book, cut out a tapered tab—shown at the bottom centre of the diagram;
- when the tab has been made, fold up your wrapper and mark out the position and length of the slot. Unfold the wrapper and cut the slot slightly larger than the width of the tab; and
- once cut and folded, the wrapper is ready for use.

How does light affect books on display?

Light is essential in a display environment; but when it is accompanied by UV radiation, it can cause extreme and irreversible damage to many of the materials found in books.

Paper can become brittle and yellow, especially if it contains lignin.

Dyes in bookcloths and leather can fade. This can be seen in books in storage as well. You often see books with faded spines. The spines are exposed to the light, while the covers are protected by being between other books.

If the books are displayed open, then inks, watercolours and photographs in the books can fade or become discoloured.

Lighting hints

As light can be so damaging to books, it is important to consider carefully the lighting of your display. The following hints can minimise damage:

- tungsten incandescent bulbs are the best form of lighting for displaying books, because they give out very little UV radiation. If you are using tungsten incandescent bulbs, make sure they are not too close to the books, because the bulbs get very hot and can damage the books. Avoid placing tungsten incandescent bulbs inside display cases because they will raise the temperature inside the cases to unacceptable levels, unless the display cases have air-conditioning or mechanical ventilation;
- fluorescent tubes give out UV radiation and should not be used unless you are using low UV-emitting fluorescent tubes; and
- it is important that books displayed open have their pages turned regularly: to prevent strain on the binding and excessive light damage to any one page.

For more information

For more information, please see the chapter on Light and Ultraviolet Radiation in *Damage and Decay*.

Supporting books when they are on display

Many books need support while being read, and all books should have support when they are on display. Severe damage can result from books being forced to open out flat; and the risks are greater for old, fragile and tight bindings.

There are a number of versatile and effective book supports which are easily and cheaply made.

Pillow support or cradle

The materials required for this support are polyester/cotton fabric, Dacron polyester wadding, sewing thread and Velcro.

The support is made first as a flat pillow. The dimensions will be determined by the size and the weight of the book to be supported. For example, an A4-volume can be well supported by a pillow of 1000mm x 350mm.

To turn the pillow into a cradle, the ends are rolled towards the centre—leaving a padded area between the rolls to support the spine of the book. The width of this central area depends on the width of the book's spine.

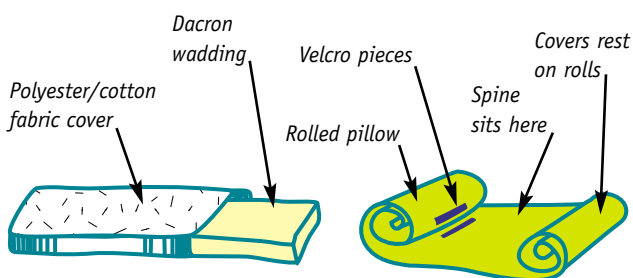

Velcro is stitched to the cradle to fix the two rolled sections in place at the correct angle to support the book for reading and/or display.

Stands for closed books

A simple stand for closed books can be made:

- using acid-free mount board for light- to medium-weight books;
- by measuring and determining the required dimensions; and

- scoring the board where it is to be folded and folding it. The folds, once set at the angle you require, can be set in place by attaching gummed, linen tape to the mount board.

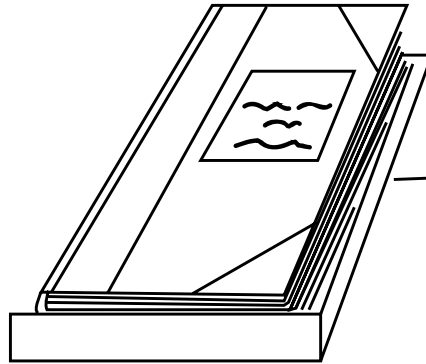

Diagrams reproduced from the Canadian Conservation Institute Note No. 11/8.

A more rigid material, such as Perspex, an acrylic sheet, can be used for larger, heavier books. The acrylic can be bent to the required shape. Most acrylic sheet suppliers can do this if you supply them with the dimensions you require and, if possible, a diagram of what you want.

Supports for open books

When displaying books open at the title page, or first or last sections of the text, support should be provided for the cover. This reduces the compression on the spine, and minimises the risk of damage to the book.

A suitable support can be constructed from acid-free mount board, folded and reinforced as described for the closed-book stand. Again the dimensions are determined by the dimensions of the book: care must be taken to make the spine strip of the book support narrower than the spine of the book.

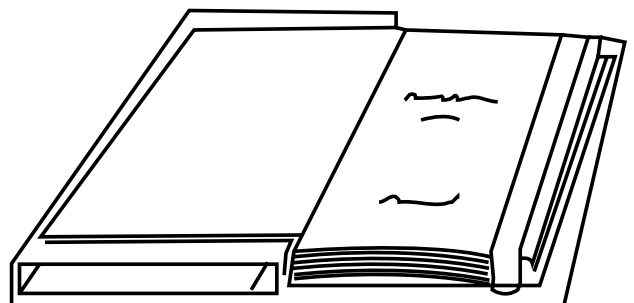

Diagrams reproduced from the Canadian Conservation Institute Note No. 11/8.

Display cases



The Mylar strip is very unobtrusive. In this photograph you can only see the Mylar because it is reflecting the lighter patches at the head and tail of the book.

Photograph courtesy of Vicki Humphrey

With some books, there will be a tendency for the leaves of the book to open and stand up. This can be prevented by placing a narrow strip of Mylar around the textblock. The Mylar can be joined end-to-end using a small piece of double-sided tape. The tape must not touch the book. It should be placed between the two ends of the Mylar.

A different type of support is needed if the book is quite thick and is to be opened in the middle or if the book is tightly bound and will not open well. Again, this support can be made from acid-free mount board or acrylic sheeting. It presents the book in a V-shaped cavity in which the book rests open at an angle of about 100°—rather than flat at 180°.

Books are often displayed in cases. Remember, while display cases are a useful method of protecting objects from the harmful effects of the environment and secure from theft and vandalism, books will still need to be supported in a case.

If you are considering using a display case, think about the materials from which it is made. Placing valuable items in cases made from materials that are potentially harmful locks them into a harmful microclimate.

Polishing the top of the display can cause electricity to build up which can make book pages fly open—or snap together. You can prevent this happening by:

- securing the pages with Mylar strips as described in the section *Supports for open books*; and
- ensuring there is sufficient space between the top of the book and the top of the display case—250mm is a good distance.

Books should not be displayed vertically with their covers open, because the weight of the paper in the textblock will cause distortion. The binding structure may even collapse.

Summary of conditions for storage and display

	Storage	Display
Temperature	18–22°C	18–22°C
Relative Humidity	45–55%RH	45–55%RH
Brightness of the Light	Dark storage is preferred for books; but if light is present it should be less than 250 lux. If you think the books are particularly light-sensitive, the brightness should be less than 50 lux.	Should be less than 250 lux. If you think the books are particularly light-sensitive, the brightness should be less than 50 lux.
	Higher lighting levels are necessary when books are being read. The brightness should not exceed 500 lux with exposure to these lighting levels kept to a minimum.	
UV Content of Light	Dark storage is preferred; but if light is present, UV content should be less than 30µW/lm and no higher than 75µW/lm.	Less than 30µW/lm and no greater than 75µW/lm.

Books in Australia's climatic zones

The climatic zones outlined below are broad categories. Conditions may vary within these categories, depending, among other things, on the state of repair of your building and whether the building is air conditioned.

Arid

This climate is generally very dry, however, in arid areas, it is often very hot during the day and very cold at night. This wide fluctuation in temperature is matched by wide fluctuations in relative humidity, for example from 75%–20%RH in a day.

When caring for books in arid areas it is important to note that:

- insects can still survive and can still damage your books;
- adhesives tend to dry out and lose flexibility, so care should be taken to open books gently;
- leather can also become very dry and lose flexibility; and
- in many arid areas there is a lot of dust and grit. For this reason book collections should be cleaned regularly. Remember grit can scratch some binding materials, so clean with care.

Remember that even arid areas can experience large fluctuations in relative humidity and temperature. You may wish to store your books in boxes or wrappers to provide them with a layer of protection from grit and fluctuations in relative humidity and temperature.

Note: If your books have been stored in an arid environment for a considerable period and they are stable—**do not** try to alter the environment to meet the recommended ideal conditions. This could do more harm than good. The emphasis should be on long term stability.

Temperate

A temperate climate is considered a moderate climate, however, temperate climates tend to have a greater range of temperatures than tropical climates and may include extreme climatic variations.

- It is probably easier to come close to the recommended ideal conditions for the storage of books in a temperate climate, however, it is unlikely that you will be able to maintain an even environment without the help of sophisticated air conditioning equipment.
- The system of layers of storage—wrappers, boxes, boxes within cupboards—will be very useful in helping to buffer against the extreme conditions that can occur in a temperate environment.
- As for all climatic zones, regular inspection of storage and display areas is important so that developing problems do not go unnoticed.

Note: If your books have been stored in a temperate environment for a considerable period and they are stable—**do not** try to alter the environment to meet the recommended ideal conditions. This could do more harm than good. The emphasis should be on long term stability.

Tropical

These climates are characterised by heavy rainfall, high humidity and high temperatures.

When caring for collections in high humidity conditions it is important to note that:

- closed books take up moisture, but are not well ventilated, thus creating an ideal environment for mould growth and for some insects;
- the rate of fading of book spines exposed to light is likely to be higher than in lower humidity conditions;
- adhesives used in the book's construction could take up moisture and become tacky and increasingly attractive to insects and mould;
- leather can become mouldy quite easily;
- some bookcloths will stick to each other if they become moist. Damage can be caused when separating them; and
- the different components of the books will take up moisture at different rates and this could lead to warping of the binding.

Regular inspections and maintenance of your book collection is important. You may be able to stop an insect or mould infestation before a great deal of damage is done. Open the books and allow air to get to the pages.

Note: If your books have been stored in a tropical environment for a considerable period and they are stable.—**do not** try to alter the environment to meet the recommended ideal conditions. This could do more harm than good. The emphasis should be on long term stability.

Book maintenance

Cleaning book shelves thoroughly and regularly helps control insects and mould growth. It is strongly recommended that you set up a system for cleaning your bookshelves regularly. This should involve removing books from shelves and cleaning behind them—insects, such as silverfish, prefer dark, undisturbed places. If you don't do this regularly, you may not notice an insect or mould problem until there is extensive damage.

Other maintenance procedures that are commonly carried out on books include cleaning individual books and dressing leather bindings. These activities are very important to keep your books in good condition; however, if they are not done properly they can cause damage.

The following sections contain information to assist you with cleaning books and dressing leather bindings.

Handy hints on cleaning books

Books are not always easy to clean. In some cases it is not wise to try to clean them thoroughly, especially if they are in fragile condition. If this is the case, you must approach cleaning with care. If you are not sure whether you should clean a damaged book, consult a conservator.

When cleaning a book, place it on a desk on a clean sheet of paper. By moving the paper around, you can reach all sides of the book easily. This method is easier and safer than trying to hold the book at the same time as you are holding the cleaning tools.

If the book is not fragile and can be cleaned without risk of damage, dust and remove loose dirt from books using gentle brushing combined with suction using a vacuum cleaner. It is vital that you reduce the suction of the vacuum cleaner. You do this by covering the end with one or more layers of a gauze-like material such as fine, Nylon stocking. By reducing the suction you reduce the

risk of damage; and the filtering gauze will prevent the loss—into the bowels of the vacuum cleaner—of any loose material which may get picked up by the suction. Sucking dirt away stops it being re-deposited in the book.

You can use a duster on the binding, but extreme care must be exercised. Rubbing with a dustcloth can cause scratching; soft calf-leather is particularly vulnerable. Dusting can also dislodge pieces of degraded leather, cloth or paper. When dusting, remember to keep turning to a clean area of the dustcloth—so as not to re-deposit dirt on the book. Remember also that if you dust without using a vacuum cleaner some of the dust will resettle onto your books.

Brushes can be used for cleaning the outside of books, and for brushing away dirt and dust which have collected inside the textblock. Soft brushes should be used: shaving brushes, sable paint brushes and jewellers and watchmakers' brushes are particularly suitable.



The text block of a book being cleaned with a soft brush.
Photograph courtesy of the State Library of New South Wales



Dust on the outside of a book being brushed away using a shaving brush.
Photograph courtesy of the State Library of New South Wales

CAUTION:

Some manuals recommend cleaning the bindings with damp cloths. If you attempt to do this, be very careful because you can damage the binding.

Degraded leathers absorb water easily, and can remain permanently discoloured where they have been damp.

Some of the sizes and pigments in bookcloths move easily in water, and wiping over with a damp cloth can leave unsightly watermarks on the binding.

Experience and knowledge of the materials are important, as is controlling the amount of water applied and the evenness of the application.

Excess water applied to the outside of a binding can distort the boards, so that they no longer protect the textblock.

Paper can be cleaned using erasers. Be very careful when doing this—and be aware that not all dirt will be moved by an eraser.

The pressure applied must be kept to a minimum, because the paper fibres on the surface of the paper are always disturbed by such cleaning. You can see this damage clearly under a microscope or a thread counter.

CAUTION:

If it doesn't clean up with slight pressure, STOP—don't rub harder and harder because you'll end up with a tear or a hole in the paper.

To clean paper with an eraser, make sure it is well supported and then rub in one direction only. Rubbing back and forth increases the risk of buckling, creasing and/or tearing the paper.

You should pay particular attention to removing the eraser particles from the paper, but some particles will inevitably remain. The brush and vacuum method of cleaning described above is very good for removing eraser particles.

CAUTION:

Do not use strong suction or you could cause extreme damage and distort the pages. Remember to reduce the suction with layers of gauze.

The eraser's quality is also important. Many modern erasers are made from polyvinyl chloride—PVC. This breaks down in the presence of moisture and produces hydrochloric acid which can cause considerable damage. The eraser should be soft and not contain abrasive materials. Staedtler Rasoplast 526 erasers are used widely for cleaning paper.

Leather dressing—a word of caution

Because leather dries out and becomes inflexible, dressing it is a widespread practice. Good-quality leather dressings improve the function and flexibility of leather, while brightening its appearance. But there are problems associated with using leather dressing.

Excessive leather dressing can stain paper, because it is very greasy. So it is important that you don't use too much and that you don't allow it to touch the paper.

Leather dressing can darken degraded leather and should not be applied to cracked or dry leather. These areas should be consolidated first.

Leather dressing can make the surface of the leather sticky, and cause dirt and dust to stick to the leather. This can be avoided by applying the dressing very sparingly and making sure you remove excess dressing by polishing—in much the same way as you do for shoes.

When applying leather dressing, put the dressing onto a soft cloth—such as an old T-shirt—and spread the dressing gently onto the book. Be gentle when polishing away the excess; again use an old T-shirt or similar. If there is any grit in the way, you could easily scratch the leather.

If leather dressing is applied over dirt and dust, they will set in place. Make sure your books are clean before applying dressing.

Leather dressing can get caught in damaged and cracked leather.

Leather dressing can discolour as it ages.

For more information

For more information on leather dressings, please see the chapter on Leather in *Caring for Cultural Material 2*.

Some miscellaneous advice

Dust jackets

Dust jackets serve a dual purpose: they protect the surface of the binding materials, but they are often far more decorative than modern bindings. They are often the first part of the book to become damaged.

Some dust jackets are important to the value of the book, and so should be protected.

If you have a valued dust jacket you want to protect, you may decide to remove it and store it safely when the book is being used. If you do this, you may want to put a substitute jacket on your book.

You may prefer to cover the dust jacket while it is on the book. If you do this, choose stable material. Polypropylene is soft enough to fold around the cover and is transparent. Mylar would be more difficult to use and has sharp corners when folded. Secure the overlaps of the covering material with double-sided tape; but don't allow sticky tapes to be in direct contact with your book or dust jacket.

It is strongly recommended that you avoid using any self-adhesive covering materials.

The adhesive used on these covering materials can work its way into the printed surface of the dust jacket, making the covering material almost impossible to remove later.

Uncut pages

Sometimes you come across a book in which the pages are still joined and the book cannot be read.

If the book is valuable or is a collector's item, it may be wise to consult a book valuer before going ahead and cutting the pages; in some cases the uncut paper can increase the value of the book.

Don't cut the pages yourself unless you feel confident that you can do the job without damaging the paper. It is very easy to end up with uneven cuts and jagged edges.

To cut the pages, it is necessary to place a very sharp knife-blade between the pages and slice carefully along the fold. You may need to use a scalpel to get right into the spine, if you are cutting at the head of the book.

If you are not confident about attempting this yourself, ask a conservator for advice or assistance.

Book conservators and bookbinders

Book conservators and bookbinders have a different approach to the treatment of damaged books. Both approaches have their place, but you may want to consider some of these differences before deciding who to consult.

Book conservators following their code of ethics should:

- aim for minimum intervention in treatments;
- use stable and reversible materials;
- retain all original materials. Even if they cannot put all of them back in place they should keep them and return them to you. This way you have all the historic evidence from the book;
- document the structure and materials in the book, as well as the damage, before commencing the treatment; and
- avoid changing the structure unless the structure itself is causing damage.

Many bookbinders work in a similar way to conservators, but you will also find that some bookbinders:

- use unstable adhesives such as animal glue, and irreversible adhesives such as PVA;
- proceed with the job without documentation;
- discard original materials and at times will not attempt to re-use them;
- alter the structure; and
- trim the head, tail and fore-edge after resewing a book. This gives a very even edge, but inevitably makes the textblock smaller.

Think about what sort of job you want and why you are having the work done—it should help you to decide who to go to for your book repairs.

MORE ABOUT BOOKS

A brief history of books

The basic form of the book with which we are familiar today has changed very little over centuries. The book remains a gathering of leaves—most commonly of paper—collected together in some way or another, in a three-dimensional, moving structure, with boards front and back to protect the leaves.

While the basic form has varied little, the materials used, the structural elements and the decorations have varied greatly over the centuries and from country to country. The invention of printing and the subsequent explosion in book production have led to further changes and developments.

Place an early book next to a modern paperback. It is obvious immediately that they are very different in appearance and appeal. But the basic form is the same.



This book was printed in 1571.

Photograph courtesy of Artlab Australia



This book was printed in 1981.

Photograph courtesy of Artlab Australia

From very early times, multiple leaves of documents were collected together in the form of a roll, with the leaves sewn together end to end. This method was used to attach pieces of papyrus together. The roll form survives today, and can be seen in synagogues: the *Scrolls of the Law* are written on sheets of parchment sewn edge to edge to form a long roll wound onto two wooden battens called *Trees of Life*.

As vellum was used more widely, its greater flexibility compared to papyrus gave rise to different methods of collecting the individual leaves together. Vellum could be folded—and so the practice of gathering groups of folded sheets and sewing them onto cords or thongs was developed. They were often wrapped in leather for protection.

Once this form of book gained wide usage, bookbinding was invented. The need to protect the leaves of the books and to keep the vellum sheets flat led to the addition of boards. The cords or thongs to which the groups of folded sheets were sewn were then laced into wooden boards. Gradually this developed into the system for binding books which is still used today.

Over the centuries boards have been covered with leather, parchment, vellum, alum tawed or whittawed skin, papers, and more recently, bookcloth. Boards have also been decorated with blind tooling, gold tooling, jewels, various metals, embroidery, beading, inlaid wood and leather, paste papers and marbled papers.

Decorative elements have not been restricted to the boards. The head, tail and fore-edge of the textblock can be painted, decorated with Armenian bole—a blood-red pigment—with gold leaf, spatter-painted with colours or gaufered. Headbands are decorative as well as functional.

At various times, different countries developed very individual styles of binding and decoration. Experts can identify the production dates and country of origin for many historic books, based solely on their physical attributes.

Over the centuries, the materials and methods of book production changed. However this has not always meant an improvement in quality. The changes are a reflection of the shift from books as rare items available only to certain sections of society to books as mass-produced consumer goods.

Boards made from compressed paper pulp have replaced wooden boards. Case bindings—in which the cover is made separately from the textblock and attached later—have largely replaced the other forms of binding in which the cover is assembled on the book step-by-step.

In the past, all books were individually hand-sewn. This type of work is generally used today for fine bindings only or conservation work. In modern book production, those books which are sewn are machine-sewn. But huge numbers of books are not sewn: they are made up of individual leaves fastened to each other and to the cover by an adhesive. This style of book—familiar to us as the paperback—is a development of the so-called perfect binding introduced in the 19th century. They are far from perfect—with a tendency to fall apart. There are other books, which have been stapled or, as bookbinders say, wire stitched.

Paper quality has deteriorated also. Acidic paper is an ongoing problem, particularly for libraries. Increasing demand for paper products in the 19th century led to many innovations in the papermaking industry, including a shift away from the traditional materials. The use of pulped wood, alum rosin sizing and papermakers' alum, to improve the flow of pulp through the papermaking machines, all contributed to the supply of reasonably cheap, mass-produced papers. These materials are also sources of acids, which attack the paper fibres—making the paper brittle and easily damaged when handled.

There is a wealth of knowledge of the history of bookbinding, and centuries of information about the durability of particular materials. This is important for historians, book collectors, museums, galleries and libraries. But this information is also valuable for book conservators, who can use it to great advantage in the preservation of old and new books alike.

Types of bindings

There are many different types of bindings. Brief descriptions of some of the more common types and some of their distinctive features follow.

Flexible style or tight-back. This was the most common binding style until the end of the 18th century, and is still used for fine binding. The term flexible refers to the spine, which ideally remains

flexible and becomes concave when the book is opened: allowing the pages to throw open fully. In this style the covering material, usually leather, is glued tightly to the spine of the textblock. So it is sometimes also called a tight-back binding.



The spine leather is glued to the spine of the text block. The thickness of the leather and the amount of glue used often prevents the spine from being flexible. Tight-back is often a more apt description.

Photograph courtesy of Artlab Australia

Library style. The library style was developed as a sturdy and durable binding which could withstand heavy use. From the middle of the 19th century in Britain, heavy demand for books to supply libraries led to many compromises in production of materials and binding techniques. At the time the look of the binding was more important than its durability. The fact that many of these bindings deteriorated led to the development of the library style. Some features of this style include the following:

- the textblock is sewn on linen tapes, rather than the less durable hemp cords;
- split boards. The boards are attached to the textblock by inserting the tapes into a split in the board; and
- the French joint. This has a space between the spine of the book and the beginning of the front and backboards, which makes it easier to open the book. The endpapers are reinforced with linen.



The joint can be seen clearly between the spine and the boards of this book.

Photograph courtesy of the State Library of New South Wales



The French joint allows the book to open fully. The linen reinforcement on the end papers makes the inside of the joint strong.

Photograph courtesy of Artlab Australia

Paperback. The term paperback really refers to the paper cover. Editions of books are either paperback or hardback. However, many people associate paperbacks with a particular style—one in which the textblock is made of single sheets held together by adhesive applied to the spine. This structure is not very durable. If you look at your book collection you will see that some modern books with paper covers are made up of folded sections sewn together. These are more durable than the adhesive style of paperback, but the covers don't really offer a lot of protection to the textblock.



A modern paperback book.

Photograph courtesy of Artlab Australia

Case binding. Many binders don't consider this a true binding. It was developed as a cheap and relatively easy method of providing protection to the textblock. The case—boards usually covered in cloth—is prepared separately. The textblock and case are attached by pasting the endpapers and

spine linings of the textblock to the inside of the case. Many of the classic, decorated, cloth-covered books, especially children's books from the first part of this century, are case bound. Case binding can be done by machine.

Limp vellum bindings. These bindings have been used for centuries. Their chief characteristic is that they don't have rigid boards. The textblock is sewn and then covered with a protective covering. This covering is often laced to the sewing cords or thongs. The style is popular as a conservation binding because it is not necessary to use adhesives. It is used with vellum as well as with paper.



This book was made in 1992. It was made in the limp, vellum style with paste paper covers instead of vellum. The text block is sewn on strips of alum-tawed goat skin. The covers are laced onto the text block using these goat-skin strips.

Photograph courtesy of Vicki Humphrey

Hollow back. The hollow is a spine lining which allows very free opening of books. The hollow lining is a paper tube attached to the spine of the textblock. The covering material is applied over the hollow. When the book opens, the covering material remains curved and supported by one half of the tube, while the textblock becomes concave and is supported by the other half of the tube.

Full binding. This name indicates that the book is covered entirely with the same material, for example, full leather, full cloth.

Half binding. Books that are half-bound have the spine with an overlap onto the boards, and the corners or foredge of the boards, covered in one material, while the remainder of the boards are covered in another. This was an economy measure as the second material was usually a cheaper one. However, it has been used to good decorative effect in many cases.



This book shows clearly the principle of the hollow back.

Photograph courtesy of the State Library of New South Wales



This book has a full leather binding and is decorated with gold tooling.

Photograph courtesy of Artlab Australia, reproduced with permission from the History Trust of South Australia



This book has leather spine and corners and paper covering the boards in half bound style.

Photograph courtesy of Vicki Humphrey

Quarter binding is another economy measure which is used decoratively. Books which are quarter bound have the spine with an overlap onto the boards, covered in one material, while the boards are covered in another.



This book has a leather spine, with bookcloth covering the boards in the quarter bound style.

Photograph courtesy of Artlab Australia, reproduced with permission from the History Trust of South Australia

Materials commonly found in books

Many materials have been used in book production over the centuries.

Paper is essentially a felted sheet of cellulose fibres. During manufacture, a range of other substances are added to produce papers with infinite differences in quality, use, strength, texture, colour and surface. Paper is an enormously



Wooden boards. The other side of these boards is covered with leather.

Photograph courtesy of Artlab Australia



This is an example of millboard.

Photograph courtesy of Artlab Australia

versatile and durable material: we have books dating back centuries which are still in good condition.

Board is a general term covering early wooden boards through to modern, machine-made boards such as pasteboard, millboard, strawboard and others.

Parchment and vellum are untanned animal skins. Their use continued in Europe even after paper was introduced. These materials are rarely found in contemporary books, but were used widely in early manuscript books. Vellum and parchment are manufactured by stretching the animal skins and treating them with lime, while scraping them to remove fats and hair.



This 13th century manuscript book was produced with vellum text block and wooden boards.

Photograph courtesy of Artlab Australia, reproduced with permission from the State Library of New South Wales



This book is bound in dyed goat skin. The boards and spine have been tooled using gold leaf.

Photograph courtesy of Artlab Australia, reproduced with permission from the History Trust of South Australia

Leathers are tanned animal skins. The tanning process gives a degree of chemical stability to the skin. Traditionally, leathers used for binding books were vegetable-tanned. This produced flexible leather with properties excellently suited for binding and decorating books.

Cloth is used in books in a number of ways:

- mull is an open-weave, cotton material stiffened with size. It is most often used as a first lining on the spines of textblocks;
- Jaconette or Holland cloth, a closely woven cotton or linen, is also used for linings and for strengthening folds of book sections; and
- bookcloths are made of closely woven fabrics with pigment fillers and sizes, and sometimes with paper linings to prevent the penetration of glue. Bookcloths can be embossed to create surface textures, and some are coated to prevent scuffing and soiling.



Bookcloths are produced in a range of colours and textures.

Photograph courtesy of Artlab Australia

Thread, cords and tape are made from linen. Linen tapes are made from woven, unbleached linen, which is stiffened with size. Cords are made from hemp fibres, spun and combined to make different thicknesses.



This book was photographed during conservation treatment. The text block was sewn onto hemp cords. Note that the spine has been lined.

Photograph courtesy of Vicki Humphrey

Various adhesives are used in bookbinding. They include:

- animal glue, which has been used for centuries. It is basically boiled-down animal skins, hooves and bones. It is used hot, and in most binderies the glue pot was kept cooking all day. Prolonged heating causes it to alter chemically and darken. Animal glue is essentially a poor-quality, impure gelatine;
- polyvinyl acetate—PVA—is an emulsion adhesive which has been used widely in recent years. It is unsuitable for most conservation applications because it is very difficult to reverse;
- starch paste is the favoured adhesive for paper repair; and
- glair, which is basically egg white, is used to fix gold leaf to the fore-edge and to the covers, for example, in the case of gold tooling.

Books can contain a range of inks and other media—iron gall inks, carbon inks, printing inks and watercolours.

These notes on materials are very brief, but serve to illustrate the variety of materials used in books. When used in books, these materials are in very close contact and will inevitably affect each other.

For more information

For more information on paper and paper deterioration, please see the chapter on Paper in this volume.

For more information about leather, vellum and parchment, please see the chapter on Leather in *Caring for Cultural Material 2*.

Paper repair

Don't try to mend torn pages or damaged covers, unless you have good-quality materials and are confident that the methods you use will not cause damage in the future. Talk to a conservator if you're not certain that you're doing the right thing, or if you want information about training courses.

If books are damaged, be aware that some repairs can cause further damage. Sticky tapes will, in the long term, cause permanent staining. In most cases, the adhesive migrates into the paper and changes chemically, becoming insoluble and discolouring, while the tape falls off. In addition to the original damage, the paper is now badly stained as well.

Similarly, many other glues and pastes introduce acids into the paper, and many also discolour with age.

If tears are extensive and large areas of the text are missing, it is best to seek the advice or help of a conservator. But smaller repairs on bound books can be carried out *in situ*.

Conservators work to a code of ethics. It is important to note some of these in relation to the repair of books, so that you can think further about the choice of materials and the methods you will use. The notes which follow describe a conservator's approach.

The treatment must be reversible, so that further treatments can be carried out in future if necessary, or so that improved techniques which may be developed can be applied.

The treatment should not disfigure or endanger the book. For example, wet treatments should not be used on material with inks that are soluble in water; and sticky tape should not be used, it stains paper badly.

The treatment and materials must match the problem. For example, heavy repair papers should not be used to repair small tears on material which is hardly used. It is better to wait till you have an appropriate repair paper.

All treatment steps should be documented with information of what was used for the repair and, if possible, with photographs of the damage before treatment.

Repairing small tears in books

Repairing torn paper or reinforcing and lining weak, degraded papers is generally a wet process—involving sticking a strong, lightweight, acid-free paper to the damaged area with starch paste.



Japanese paper repairs can be seen on the lower left corner and at the head of the book. The book is being held open by a Mylar strip which is reflecting light.

Photograph courtesy of Vicki Humphrey

Japanese papers are excellent for paper repair because:

- they are lightweight and strong, and their colours blend well with most papers;
- Japanese papers have long fibres—in comparison to most Western papers—this gives them their strength;
- if you decide to purchase some of these papers, ask for conservation-grade Japanese papers. Small packs of a range of papers are available from suppliers of conservation materials. You won't need very much paper to repair small tears;
- they are usually handmade and suited for conservation. Papers such as Sekishu, Tengujo and Usumino are well-suited to book repairs because they are very fine and do not obscure the text; and

- these papers can also be water-cut, giving very soft edges to the repair patch. Knife-cut edges show as a hard ridge.

Paper can be water-cut like this:

- paper strips are water-cut using a fine brush, letter opener or bone folder, spatula and ruler;
- a stainless steel ruler is placed along the repair paper, with the required amount of paper protruding beyond the ruler;
- the wet brush is drawn along the ruler edge, wetting the paper: the paper should not become too wet;
- the letter opener, bone folder or spatula is then drawn along the ruler—to score the wet paper; and
- the strip of paper can then be pulled away from the rest of the sheet of paper.

The repair should not be much larger than the damaged area, but needs to be big enough to extend beyond the damage onto the sound paper around it. This makes a stronger repair. The feathered edges of the water-cut paper contribute to the strength of the repair, because they are all stuck down as well.

Paper strips are not always suitable for repair, and you may have to produce your own shapes. This can be done by needling out the shape using a mattress needle or the sharp end of a bone folder. Once you have made an impression in the repair paper with the needle or bone folder, apply water to the impression. Pull the shape away from the rest of the paper.

CAUTION:

Do not needle out a shape while the repair paper is resting on your book. If you do this you will create a weak area in the book paper. You can outline the shape required on the repair paper with a soft pencil, before you commence needling.

When repairing a page of text, remember:

- wherever possible, place the repair so that it does not cover text; and

- place the repair on the side of the page where the repair will be least obtrusive.

The repairs are stuck in place using starch paste. It is at this stage that difficulties can arise.

Always apply the paste to the repair paper, never to the book pages. You should also allow the paste to air-dry till it is almost dry before placing it on the dry, book page. This will help to reduce the risk of cockling and tidemarks.

Once pasted, the paper can become difficult to handle, but with practice the operation becomes easier.

Once the repair is in place, it wets the book paper, which will expand where it is wet. Because only small areas are wet, you will notice that it cockles. Controlling the drying is important for these cockles to settle back down.

While drying, the repair should be sandwiched between:

- Reemay, which will prevent the blotter sticking to the repair; and
- blotters, which should be changed regularly, to ensure that the moisture absorbed by them is removed from the repair area.

This sandwich should be weighted.

It is important that the paper is fully dried. Don't rush this, as paper can sometimes take a couple of weeks to dry fully.

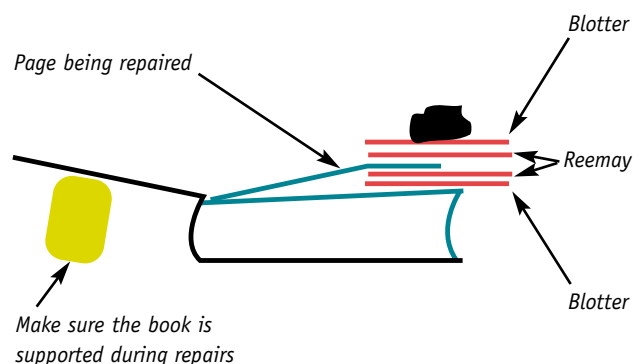

CAUTION:

Repairing tears in books is not as easy as it might seem, and we strongly advise you to practise this before attempting it on a book.

Wet paper will expand and distort, but with practice you can control the drying, so that the distortions flatten out without creasing.

It is also important to note that if you get the paper too wet during repair, you can produce permanent stains like 'tidemarks' in the paper.

IF IN DOUBT DON'T DO IT!

Starch paste

Starch paste is the adhesive used most widely by paper conservators. Starch paste from various sources—for example, wheat or rice—has been used for centuries to stick paper to paper, and textiles to paper. And because it has been used for so long, we know a great deal about its behaviour. Some of its greatest advantages are that it does not discolour and it is nearly always possible to remove it without difficulty.

Starch paste is not difficult to make. You will need:

- 10 grams or 3.5 level teaspoons of starch, for example, Silver Star; and
- 100ml of water, preferably distilled or deionised.

These proportions produce a nice working consistency.

- Add about 10ml of the water to the starch, and mix to a slurry.
- Add more water, if required, to produce a smooth paste, and leave to soak for approximately half-an-hour.
- Heat the remainder of the water in a double-boiler saucepan, or in a beaker or jar in a saucepan of boiling water. Use glass or stainless steel containers.
- Add the starch slurry and cook for approximately 40 minutes, stirring constantly.
- Leave to cool.

Lumpy paste is difficult to use and the lumps will be obvious, so when the paste is cool press it through a fine cloth—Terylene, for example—or push it through a fine, Nylon tea strainer or sieve a couple of times.

The paste is now ready to use. Or it can be diluted if a thinner paste is required—this is best done by mixing the paste and the required amount of water in a blender. Remember, the thinner the paste the stronger the adhesive bond.

When using an adhesive on a valued, paper-based item, it is important to know just what you're applying to the paper and how it is likely to behave over time. Many commercially available adhesives are starch-based, but most of these adhesives also have additives such as:

- preservatives;
- plasticisers, for example, glucose, to regulate the drying speed;
- dispersing agents; and
- mineral fillers to control penetration of the adhesive into porous surfaces.

These substances, which can affect the long-term behaviour of the adhesive, are rarely listed on the label.

If you have a problem relating to the storage or display of books, contact a conservator. Conservators can offer advice and practical solutions.

For further reading

Baynes-Cope, A. D., 1989, *Caring for Books and Documents*, 2nd ed, British Library, London.

Bromelle, Norman S., Thomson Garry (eds.), 1982, *Science and Technology in the Service of Conservation*, Preprints of Contributions to the Washington Congress, 3–9 September 1982, International Institute for Conservation of Historic and Artistic Works, London.

Burdett, Eric, 1975, *The Craft of Bookbinding—A Practical Handbook*, David and Charles, Newton Abbot, UK.

Diehl, Edith, 1980, *Bookbinding: Its Background and Technique*, two volumes bound as one, Dover Publications Inc., New York.

Gettens, Rutherford J. & Stout, George L., 1966, *Painting Materials, A Short Encyclopaedia*, Dover Publications Inc., New York.

Johnson, Arthur W., 1978, *The Thames and Hudson Manual of Bookbinding*, Thames and Hudson Ltd, London.

Middleton, Bernard C., 1984, *The Restoration of Leather Bindings*, Adamantine Press Ltd, London.

National Preservation Office, 1991 *Preservation Guidelines*, National Preservation Office, British Library, London.

Thomson, Garry, 1994, *The Museum Environment*, 3rd edn, Butterworth-Heinemann, Oxford.

Some of the methods described in the bookbinding manuals are not ones that would be employed by paper and book conservators. However, these books give very clear descriptions and illustrations of bookbinding styles, methods and materials. Some have excellent glossaries and notes outlining the history of different binding styles.

Self-evaluation quiz

Question 1.

The causes of damage to books can be broadly divided into two categories—physical damage and chemical damage. Name three examples of each.

Question 2.

When photocopying a book, you should:

- be aware that its structure may not have been designed to open out flat;
- force the book to open as flat as possible and press the photocopier cover down over the book to get a better quality copy;
- take note of what you are intending to copy and consider that some materials may be sensitive to strong light;

- open the book as far as you can until it makes a crackling noise and then stop;
- if the book does not open fully, consider taking notes rather than copying.

Question 3.

Indicate which of the following can damage books:

- opening new books gradually from the front and then the back, section by section, until you reach the middle;
- removing books from shelves by pulling at the top of the spine;
- pressing flowers in books;
- wearing gloves when handling gold-tooled bindings;
- flicking quickly through pages;
- licking your fingers for easier page turning;
- repairing books with sticky tape;
- folding the corner of the page to mark your place;
- leaving the book open over the arm of the armchair while you go to get tea and cake to have while reading.

Question 4.

What are the ideal temperature and relative humidity ranges for storage and display of books?

- 30°C and 60%RH
- 10–16°C and 45–55%RH
- 18–22°C and 10–20%RH
- 18–22°C and 45–55%RH

Question 5.

What happens to books that are badly shelved and are allowed to flop to the side?

- The bindings distort over time.
- Nothing happens.
- The sewing structure can break down.

- d) They can fall apart.

Question 6.

Of the following materials, which are good to use for making storage and display furniture for books?

glass, uncured paint, PVA glue, enamelled metal, protein-based glues, for example, animal glue, inorganic pigments, chipboard, ceramic, cellulose nitrate, wool, polyester film, polystyrene, felt, polyurethanes, cotton, linen, PVC, unsealed woods especially hardwoods, acrylic polymers.

Question 7.

Which of the following statements are true?

- a) All books should have support when they are on display.
- b) Phase boxes are called this because they are boxes which are made in phases.
- c) Wrappers can protect books and are straightforward to make.
- d) Books which are displayed open should have their pages turned regularly to prevent light-damage to any one page.
- e) Light and UV radiation have no effect on books.
- f) Book pages can be prevented from moving during display, by placing a Mylar strip joined end-to-end around the open book.

Question 8.

In a tropical climate books are likely to:

- a) dry out leaving the glues very brittle;
- b) absorb moisture and develop mould;
- c) get very dirty;
- d) lose pages.

Question 9.

When dusting books it is important to remember that:

- a) sucking dirt away with a vacuum cleaner stops it being re-deposited on the book;

- b) if using suction, precautions should be taken to reduce the suction so that it does not cause damage;
- c) erasers can be used with extreme care, to clean paper;
- d) shaving brushes should be new, if they are to be used for cleaning books;
- e) all of the above.

Question 10.

Which of the following statements are false?

- a) All books should be treated with leather dressing.
- b) There are no problems at all with using leather dressing on books.
- c) Leather dressing can stain paper because it is very greasy.
- d) Leather dressing can make the surface of the leather sticky, causing dirt and dust to stick to the leather.
- e) Leather dressing removes dirt and dust.

Answers to self-evaluation quiz

Question 1.

Physical	Chemical
dog-eared pages	fading of textblock
tears to pages	fading of binding materials
loss of pages	discolouration of textblock
broken joints and detached covers	discolouration of binding materials
scuffing, wearing and losses to cover materials	deterioration from mould growth damage from pollutants
insect attack	red rot
distortion	

wear and tear

Question 2.

Answer: a), c) and e). It is important to be aware that you can cause damage if you photocopy books, and you should proceed with caution. Photocopiers which have a V-shaped copy-bed are available, so ask at your State library. If they have one of these, they may be able to supply you with the copy you need without you damaging your book. If you open out the book and hear crackling sounds, you are probably breaking up the adhesive film on the spine of the book.

Question 3.

Answer: All except a) and d) are damaging. a) and d) could be damaging if you don't take adequate care.

Question 4.

Answer: d). These are the ideal conditions but they cannot always be achieved.

Question 5.

Answer: a), c), and d) are all likely to occur. a) will happen first, followed by c) then d).

Question 6.

Answer:

GOOD	BAD
acrylic paints and varnishes	uncured paint
cotton	wool
linen	felt
inorganic pigments	PVA glue
polystyrene	PVC
polyester film	cellulose nitrate
ceramic	polyurethanes
glass	protein based glues, for example, animal glue
enamelled metal	chipboard, unsealed woods—especially hardwoods—Customwood

Question 7.

Answer: a), c), d) and f) are true. b) is false. These boxes are called phase boxes because they are used in libraries in phased conservation programs. e) is false. Light and UV radiation can cause extensive damage to books.

Question 8.

Answer: b). In damp conditions books are likely to absorb moisture and grow mould if they are not well-ventilated and inspected regularly. Books could get very dirty and lose pages as well, but this would not be the result of the climate alone.

Question 9.

Answer: e).

Question 10.

Answer: a), b) and e) are all false. Only leather-bound books should be treated with leather dressing—and even some of these should not be treated unless the leather is consolidated first. Leather dressing should be used with caution because there are a number of problems associated with its use. If leather dressing is applied over dirt and dust, they set in place.

PHOTOGRAPHS

Objectives	page 69
Introduction	page 69
Types of photographs	page 69
What are the most common types of damage?	page 70
Common causes of damage	page 72
The do's and don'ts of handling photographs	page 72
The do's and don'ts of labelling and repair	page 73
Storing photographs	page 74
Practical steps you can take to improve your photographic storage	page 77
Easy do-it-yourself methods for storing photographs	page 80
Displaying photographs	page 83
Summary of conditions for storage and display	page 88
Photographs in Australia's climactic zones	page 88
Some miscellaneous advice	page 90
MORE ABOUT PHOTOGRAPHS	
A brief overview of the chemistry of photography	page 91
A brief overview of photographic deterioration mechanisms	page 92
Layer structures for various photographs	page 93
A brief history of the development of photography	page 93
Identification of historic photographs	page 98
For further reading	page 103
Self-evaluation quiz	page 105
Answers to self-evaluation quiz	page 106

Objectives

At the end of this chapter you should:

- have a basic knowledge of the main problems facing collections of historic photographs;
- have an awareness of the different types of photographs and their different deterioration patterns;
- know about appropriate storage and display techniques to ensure the preservation of photographic collections; and
- be able to manage photographic collections in your care, so that access to the collections is assured while at the same time the collections receive maximum protection.

Introduction

Since its invention in 1839, photography has enjoyed enormous success. It has gone from being something quite rare and mysterious to something quite everyday—commonplace. Unfortunately, because photographs are everyday items we don't always give them the care that they need.

All photographs, both old and new, require special care. Many photographs, including modern colour photographs, are unstable, and will fade rapidly if they are not processed properly in the first place, if we display them for long periods and if we do not store them appropriately. In some cases, this can result in the complete loss of the photograph.

Compromise is nearly always necessary when trying to find a balance between using and preserving



Silver gelatin
Photograph—c1930.
*Photograph courtesy
of Fred Francisco*

collections. However, there is much that can be done to preserve the photographs in your care, through careful and thoughtful handling, storage and display.



Silver gelatin
Photograph—c1910.
*Photograph courtesy
of Fred Francisco*

Types of photographs

There is a huge range of different types of photographs. These sections on keeping photographs apply, among others, to:

- daguerreotypes;
- colour photographs;
- salted paper prints;
- cyanotypes;
- collodion prints;
- silver-gelatin prints;
- safety film negatives;
- glass plate negatives;
- modern colour prints on resin-coated papers.
- ambrotypes;
- opalotypes;
- platinotypes;
- albumen prints;
- carbon prints;
- slides;
- tintypes;
- Cibachromes; and

These types of photographs differ in their components and chemistry, and the base on which the photograph is produced.

For more information

For more information about the components, chemistry, structure and history of these different types of photographs, please see the section More About Photographs later in this chapter

What are the most common types of damage?

Probably the most obvious damage you will see is physical damage. This includes problems such as:

- tears;
- creases. These almost always cause tiny splits or fractures in the emulsion;
- dog-eared corners. These also cause tiny splits or fractures in the emulsion layer;
- insect attack. The materials used to make photographic emulsions are a good food source for some insects. Insects, mice and rats will also eat the paper base of photographs;
- abrasion and scratching. Photographic emulsions are made from materials such as gelatine and albumen—egg white. These materials form very smooth films, which are very easily scratched when rubbing against other photographs and rough paper surfaces such as album pages;
- indentations in the photograph where labels have been written or typed directly onto the back of the photograph. If excessive pressure has been applied, the emulsion can be fractured; and
- emulsion peeling away from the paper base.



A photograph showing damage caused by creasing.

Photograph courtesy of Fred Francisco



Dog-eared corner, leaving heavy creases and tears in the photograph.

Photograph courtesy of Fred Francisco



This photograph is severely damaged with a large tear and losses.

Photograph courtesy of Monique Godelle



Silverfish attack to emulsion and cardboard mount.

Photograph courtesy of Artlab Australia, reproduced with permission of Mortlock Library, the State Library of South Australia



Indentations caused by writing on the back of the photograph.

Photograph courtesy of Fred Francisco

- photographs which have broken or fractured emulsion are more susceptible to chemical deterioration.



The whole image has yellowed and become warmer in tone. The small spots are fly specks.

Photograph courtesy of Fred Francisco



The emulsion is badly cracked and is beginning to peel away from the paper base.

Photograph courtesy of Artlab Australia, reproduced with permission of the History Trust of South Australia

The other most obvious damage is the result of chemical deterioration:

- fading of the photographic image, accompanied by loss of detail;
- yellowing of the image. In many historic black and white photographic processes, the image becomes warmer in tone and changes from blacks, whites and greys to browns and yellows;
- colour change and fading of colour prints, negatives and slides. Colour prints are most susceptible to this type of damage;
- silver mirroring—silvering out—in shadow areas. This is such a common symptom that nearly all 19th century gelatine developing-out prints are affected;
- staining. Stains can develop on photographs. Some come from within the photographs and others from the materials that are in contact with the photographs, such as album pages and sticky tape; and



Some areas of this photograph are beginning to fade, with detail being lost.

Photograph courtesy of Fred Francisco



The colours in these photographic prints have altered over time and are no longer very realistic.

Photograph courtesy of Vicki Humphrey



Silver mirroring—silvering out—can be seen around the edges of the photograph.

Photograph courtesy of Artlab Australia, reproduced with permission of Ann V. Nicholas

Common causes of damage

All the most common types of damage are caused by:

- poor handling;
- poor storage methods;
- inappropriate display methods;
- chemical changes in the photograph;
- chemical changes caused by chemicals that are present in materials in contact with the photographs; and
- a combination of any or all of the above.

The following sections will outline practical steps you can take to minimise damage.

The do's and don'ts of handling photographs

Handling photographs with care and commonsense helps prevent damage. Because photographs are highly susceptible to physical damage from improper and frequent handling, you should handle them as little as possible.

When you must handle them, make sure your hands are clean. You can wear gloves for added protection—cotton gloves are often recommended—but they are not always appropriate because they can make it much harder to pick up individual photographs. Clean, close-fitting, surgical gloves are a good alternative to cotton gloves.

Old photographs can be very brittle, particularly if they already have tears and creases. So it is important to give them proper support when handling them. New photographs also need support so that they are not damaged.

If you must pick up a photograph to examine it closely, it is better to place it on a rigid support, like a piece of cardboard, and lift the board.



This fragile and damaged print is being supported on a rigid support during handling.

Photograph courtesy of Artlab Australia

Holding a photograph in your hand can make it curl and involves greater risks of damage. If you must carry photographs over any distance, they should be carried horizontally and supported on a rigid support, like a piece of cardboard. Even if photographs are mounted on cardboard, don't tuck them under your arm to carry them. They should be supported as described above. Many old photographs were mounted on board which



The backing board for this photograph became brittle and snapped in two, breaking the photograph at the same time.

Photograph courtesy of Artlab Australia, reproduced with permission of the History Trust of South Australia

becomes very brittle over time. If these boards break, the photographs attached will break as well. Placing them in folders, Mylar pockets, Copysafe sleeves or polyethylene bags provides added protection.

Photographic emulsions are easily scratched and need to be protected when you are handling more than one photograph at a time. You can protect them by separating them or interleaving them, ideally with archival materials such as photographic storage paper, Mylar and acid-free glassine. For short-term interleaving, silicon release paper or other papers with a very smooth surface can be used.

CAUTION:

Papers which are very opaque, white and have a very smooth almost shiny surface are not suitable for interleaving. These papers are called coated papers and have a finely ground, mineral coating. When they are wet they become very sticky.

Make prints of frequently-used photographs. The copy prints can be used as the working records, instead of the originals; and the negative can be used to produce new copies when the first ones wear out. The original photographs can be stored safely.

The do's and don'ts of labelling and repair

Inappropriate labelling and repair methods can damage photographs. The following guidelines can help prevent damage.

Biros, other ink pens and markers should not be used to label photographic prints. Many of these inks, particularly felt tip pen inks, can spread and cause unsightly staining.

When it is necessary to label a photographic print, write in soft pencil—a B pencil is good—on the edge of the back of the print. Don't apply pressure because this can leave indents in the photograph and can fracture the emulsion.

Sometimes it is necessary to label negatives. This must be done with extreme care. It is best to use a permanent ink, such as Indian ink. The information should be recorded on the very edge of the

negative, outside the image area. It is very difficult to write on the shiny side of the negative, so write on the duller side: this is the emulsion side of the film.

Paper clips, even plastic ones, can damage and distort photographs. They should not be used for attaching labels, even temporary ones, to photographs. If you need to place a temporary label with a photograph, write it on a piece of paper large enough to fold around the whole photograph.

Do not mend photographs using self-adhesive sticky tapes of any kind.

These tapes go through a number of stages when they deteriorate. Firstly, the adhesive becomes very sticky and will be absorbed easily into paper, fabrics and emulsions. In the next stage, the adhesive changes chemically and begins to yellow and eventually turns a dark orange. At this stage the adhesive is almost totally insoluble and the stains cannot be removed.



These photographs were attached to a scrapbook page using masking tape. The adhesive became sticky and stained the photographs.

Photograph courtesy of Artlab Australia, reproduced with permission of C. Braham

If you have a damaged photograph, place it in a protective sleeve or wrapper, to prevent further damage until you can get advice from a conservator.

Never use adhesives such as rubber cement with photographs. It ages in the same way as sticky tape adhesives and contains sulphur. Sulphur reacts chemically with photographs, which are made up of silver particles.

Storing photographs

Adverse storage conditions affect all items in a collection. The effects are not always dramatically obvious. Changes occur gradually over a long period of time. However, once the changes have occurred they are often irreversible, or involve complex and costly treatment.

A good storage environment can prevent physical damage, help slow down chemical deterioration, and greatly increase the life of photographs. The following sections outline:

- the ideal conditions for storing photographs;
- general storage guidelines;
- the best materials to use for storing photographs;
- practical steps you can take to improve your photographic storage, even when conditions are not ideal; and
- some easy, do-it-yourself methods for storing photographs.

Ideal conditions for storing photographs

Ideally, photographs should be stored in an environment where:

Temperature is kept low. The level recommended by Kodak for storing 19th century photographs is 15°C. As this is difficult to achieve at home and in most working environments, a more realistic level has been set at 18°C. Daily fluctuations in temperature should be no more than 4°C. In some areas, this is extremely difficult to achieve.

Relative humidity is in the moderate range of 30–50%RH. The control of relative humidity is very important when storing photographs. Within the 30–50%RH range, conditions are dry enough to inhibit chemical reactions and the growth of mould; but it is also moist enough for paper and photographic emulsions to remain flexible.

Fluctuations in relative humidity should be kept to a minimum. This is important because the paper and emulsion components of photographs react at different rates to changes in relative humidity.

With extremes or rapid fluctuations in relative humidity, the paper and gelatine layers can pull away from one another.



This print has curled because the paper and the emulsion lose moisture at different rates. The gelatine has shrunk faster than the paper and pulled it into a curled position.

Photograph courtesy of Fred Francisco

For more information

For more information about temperature and relative humidity, please see *Damage and Decay*.

Light is kept to a minimum. Light is required only when the photographs must be viewed: for example, when they are on display, being accessioned or being used for research. Information about appropriate lighting levels are given in the section Ideal Conditions for the Display of Photographs.

Photographs are protected from pollutants, dust and insects.

For more information

For more information about the damaging effects of light, dust, pollutants and insects please see *Damage and Decay*.

General storage guidelines

Careful consideration should be given to the storage site and the storage systems. In situations where you can achieve the ideal conditions, a good storage system in an appropriate storage site gives added protection to your collection. If the available facilities or the local climate make it difficult for you to achieve the ideal conditions, the selection of the storage site and the storage

system you use become even more critical in preventing damage to the collections.

The following notes are guidelines for selecting storage sites, and outline the principles to be followed for protecting your collections in storage.

The storage site should be in a central area of the building where it is buffered from the extremes of climatic fluctuations which can occur near external walls, in basements and in attics. Don't store photographs in sheds.

The storage site should not have any water, drain or steam pipes, particularly at ceiling level. Leaking pipes can cause a lot of damage. Storage systems should be easy to use and accessible. Ease of use and accessibility usually mean that things will get less damaged during handling. Frustration with a difficult system can lead to damage.

Standard-size photographs, glass negatives and magic lantern slides should be stored vertically. This makes sorting through the collection to find things much easier than if they are stacked one on top of the other. It also avoids the situation where one photograph has to carry the weight of those stacked on top of it.

Flat storage is preferred for larger photographs because they don't have the rigidity to support their own weight in vertical storage. If they are stored vertically they will tend to bow.

CAUTION:

It is undesirable to stack a large number of photographs one on top of the other. The items on the bottom of the stack would have to take the weight of those above. If they were stored in high humidity conditions, the emulsion could become sticky, and the photographs on the bottom of the stack would stick to their wrappers or interleaving sheets.

Dividers or secondary boxes should be placed within storage boxes or filing cabinets. Dividers reduce the movement of items within the storage system, and provide additional support to the stored items.

Layers of storage should be provided. This gives maximum protection from:

- fluctuations in relative humidity and temperature. This is especially important in areas where the ideal levels of relative humidity and temperature cannot be achieved—the multiple layers of storage act as a buffer zone between the photographs and the extreme or fluctuating conditions;
- dust, pollutants and insects; and
- the damaging effects of light.

Each photograph should have its own protective wrapper or enclosure to protect it. Further layers of protection should be provided. Individually wrapped photographs should be boxed.

Labels should be provided on the outside of storage and housing systems, so that items can be located easily without having to search through and inspect every similar item.



A protective four-flap wrapper for photographs.
Photograph courtesy of Artlab Australia

For more information

Instructions for making a four-flap wrapper for photographic storage are given in the section Easy do-it-yourself Methods for Storing Photographs, later in this chapter.

The best materials to use for storing and displaying photographs

There are many materials which provide a very safe and protective storage environment for photographs. There are also materials which should not be used because they can accelerate the deterioration of photographs. The list below summarises the good and bad materials.

GOOD	BAD
photographic-quality rag and wood pulp papers	poor-quality papers such as newsprint or butchers' paper
plastics such as archival-quality polyester and polypropylene	black papers and boards—these often contain sulphur
photographic storage paper	coloured papers and coated papers
photographic, museum or conservation-quality mount board	PVC (polyvinylchloride) a common plastic
metal furniture with baked enamel finish	furniture made from uncured wood or recently painted furniture

Wrappers, enclosures and mounts—anything which is in direct contact with the photographs—should be made from materials which are chemically inert, that is, they will not cause chemical damage to the photograph. Nor should the wrappers, enclosures and mounts cause physical damage.

Preferred papers and boards for photographic storage are those made from cotton or linen, or wood-pulp papers which have been treated to remove harmful chemicals. These papers are considered to be photographic-quality storage papers, and are available from conservation material suppliers. Research shows that papers containing alkaline buffering, which are used widely for storing archives and works of art on paper, should not be in direct contact with photographs, but can be used for outer storage layers.

Plastics used widely for photographic storage are archival-quality polyester films such as Mylar D and polypropylene. Mylar is clearer and offers more support to the photographs than polypropylene. Polypropylene is cheaper and readily available. Copysafe sleeves are suitable polypropylene enclosures. Tyvek, a spun, bonded polyethylene is also suitable for wrappers for photographs.

CAUTION:

Plastics can severely limit air flow around photographs and this can lead to mould growth and sticky emulsion.

Abrasion is a major problem for photographic emulsions, especially for gelatine. Therefore, the material which is in direct contact with the emulsion must be very smooth and slick, like the surface of the photograph. An already abraded photographic emulsion will abrade Mylar and photographic storage paper.

Boxes should be made from good-quality materials. If non-archival boxes are to be used they should be lined with a good-quality paper or board.

Ideally, storage furniture should be metal, with a baked enamel finish. Wood gives out active chemicals, sometimes for many years. Wood polishes and varnishes also contain substances which can damage photographs.

Materials to **avoid** are:

- poor-quality papers. Many poor-quality papers become acidic over time. Acids attack the paper fibres, causing the paper to become brittle and crumbly. Acids from these papers can migrate to the photographs and cause damage to the emulsion, the photographic image and the paper base. Ordinary cardboard boxes and film boxes are not recommended for storing photographs for the same reasons;
- sulphur-containing materials. Remember that sulphur tarnishes silver, and photographs are silver-based. Avoid any papers and boards which may contain sulphur. Even good-quality wood-pulp papers contain sulphur. Black dyes used to colour black paper often contain sulphur. Rubber cements and rubber bands also contain sulphur and should be avoided; and
- plastics. Never store photographs in plastics such as polyvinyl chloride—PVC. The PVC in folders and storage sleeves breaks down in the presence of atmospheric moisture, to produce hydrochloric acid. This is a strong acid which will cause irreversible damage to your collections.

Practical steps you can take to improve your photographic storage

Housekeeping is important; storage areas should be kept clean and inspected regularly for mould and insect activity.

Cleaning materials containing chlorine bleaches or ammonia should not be used near photographic collections. Neither should naphthalene, insecticides and fungicides. These are active chemicals which could adversely affect photographs, especially in an enclosed storage environment.

Layers of storage should be provided, with each photograph having its own individual wrapper wherever possible. If you are storing photographs flat, take care not to stack too many individual items on top of others; heavier and larger items should be placed on the bottom of the stack.

Don't store photographs in boxes on the floor. And also take care not to stack too many storage boxes on top of each other. This can make access difficult, damage the collections and increases the risk of injury.

Individually wrapped photographs should be boxed. If you are purchasing storage boxes for your collections, consider buying clamshell or drop-back boxes. These are the same style as Solander boxes and are the preferred design because they allow easy access to all items.



Clamshell or drop-back box with loose-leaf binder incorporated into the box.

Photograph courtesy of Artlab Australia, reproduced with permission of South Australian Museum

There are a number of other photographic storage systems, which are available from suppliers of conservation materials.

If you are not able to buy new boxes, you can modify your existing boxes, or use ordinary cardboard boxes and film boxes. These are not ideal, but can be upgraded by lining them with polypropylene, polyester or a good-quality rag paper. You can also seal them with acrylic varnish or acid-free polyvinyl acetate—PVA—but remember that the sealant must be allowed to cure for at least two weeks. Alternatively, you could make your own boxes.

For more information

For instructions on making acid-free storage boxes, please see the chapter on Books in this volume.

Instructions for making a four-flap wrapper for photographic storage are given in the section Easy do-it-yourself Methods for Storing Photographs, later in this chapter.

Framed photographs

The glass, frame and mat should be clean. Inspect each item for insects and mould before storing it. Remove the screw-eyes and wire from the frames, because they can scratch and damage other items they come into contact with.

Wrap each framed work in acid-free paper or Tyvek, to protect it from dust and reduce the risk of insect attack, and place it upright in a sturdy box.

Group items according to size; when the sizes vary greatly, place a cardboard spacer between the dissimilar frames. If different sizes are mixed, frames can become distorted and can damage each other.

Mounted or matted photographs

Window mounts provide some protection. However, the surface of each photograph should be protected by covering it with an acid-free, non-buffered, interleaving paper, or by wrapping the mounted photograph in a four-flap wrapper.

Mounted photographs can be stacked flat, but numbers should be limited to five items per stack. The larger the photographs the fewer should be

stacked: the weight of stacked items can damage the image layer of the items at the bottom.

Don't stack photographs if you have problems with high or fluctuating humidity. The emulsion could become damp and the weight of other photographs could cause the wrapper to stick to the emulsion. Loosely packed, vertical storage is preferred.

Group the photographs according to size.

Don't overfill storage boxes. The boxes should be of an appropriate size to allow easy access, but also to minimise movement of items within the box.

If a box is not full, the photographs may bend. The empty space can be filled by placing a sandwich of two museum-quality mount boards with acid-free tissue filler in the box.

When moving the photographs, and if storing upright, maintain the correct orientation of the photographs. If mounted correctly, the photographs will be hinged at the top. Maintaining the correct orientation ensures that the hinges are not placed under unnecessary strain.

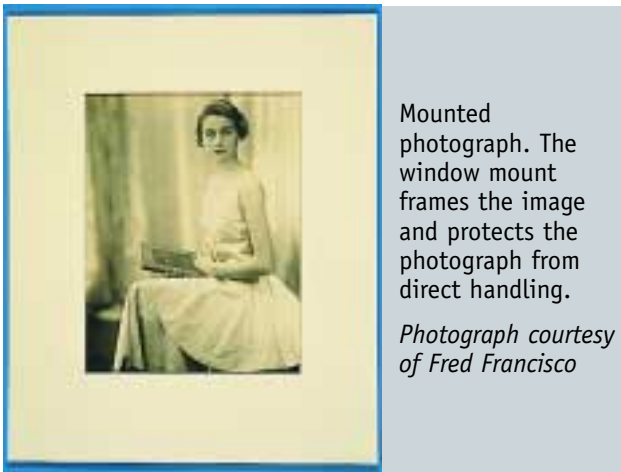

Mounted photograph. The window mount frames the image and protects the photograph from direct handling.

Photograph courtesy of Fred Francisco

Loose photographs

As far as possible loose photographs should be stored according to the storage principles outlined above.

Wherever possible wrap each photograph in a four-flap wrapper made from good-quality materials such as photographic storage paper.

If individual wrappers or enclosures are not possible, the photographs should be interleaved with acid-free non-buffered paper and stored in boxes. Movement

within the boxes should be minimised. If a box is not full, the photographs can bend and crease, corners can break and they can tear.

Albums are another alternative for storing loose photographs. Loose photographs can be kept in archival-quality photograph albums. It is important to note that most commercially available albums are not of archival quality.



Collection of loose photographs before storage.

Photograph courtesy of the History Trust of South Australia

Cased photographs

Each daguerreotype and ambrotype usually has its own protective case; and these cases are largely responsible for their preservation. The cases are an important part of the object and should be protected and kept clean.

Each case should be wrapped, or have a dust cover made to fit. Cased photographs can be stored in an appropriately sized box or four-flap wrapper made from good-quality materials.



A cased daguerreotype.

Photograph courtesy of Artlab Australia, reproduced with permission of the Art Gallery of South Australia



A cased ambrotype.

Photograph courtesy of Fred Francisco.

Photographic negatives and slides

Store negatives in acid-free paper negative holders or in polypropylene negative sleeves in ring binders.

Slides can be stored in metal slide files, carousels or trays, covered to keep out dust. Sleeves are available for storing slides in filing cabinets. If the sleeves are of good-quality materials and hold the slides securely, this method is effective. It is important not to overfill the filing cabinet drawers. Easy access leads to better handling.

Plastic sleeves are not recommended in situations where there are problems with high or fluctuating humidity. Plastic sleeves restrict air flow and they can stick to moist emulsion.

Glass negatives and magic lantern slides

Each negative or magic lantern slide should be in its own four-flap wrapper made from good-quality materials such as photographic storage paper.

Storage boxes need to be strong and rigid—to give maximum protection to the glass.

A collection of glass negatives or slides is quite heavy and the storage box must maintain its rigidity when lifted. As the glass is heavy, consider splitting your collection into a number of boxes, rather than putting them all into one. This will protect your collection and be much easier on the people who have to retrieve or carry the boxes.

Line the bottom and sides of storage boxes with Plastazote, a polyethylene foam. This material absorbs impact and helps protect the fragile glass negatives and slides.

The negatives and slides, in their wrappers, should fit snugly into the box—to minimise movement.

Store the slides or negatives vertically in the storage box. Place a piece of Plastazote about every ten slides-to absorb any impact and to minimise movement.

Group the slides and negatives according to their size.

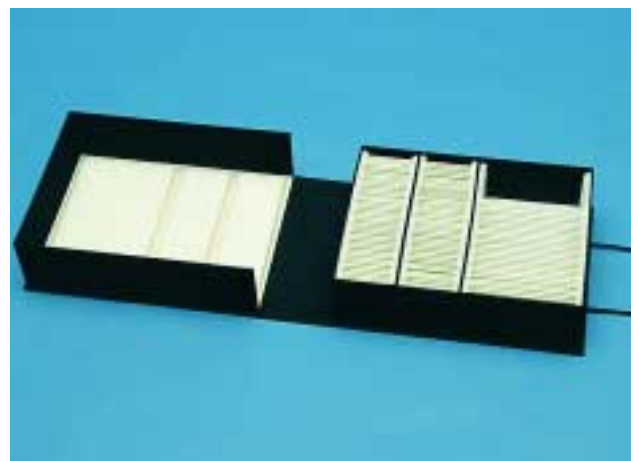

Glass negative or magic lantern slide storage box. Note that each individual item is wrapped.

Photograph courtesy of Artlab Australia

Opalatypes

Opalatypes are photographs on opaque glass and are 100 years old. Remember that this old glass is very brittle and the slightest bend will cause a break.

Opalatypes need a rigid support system.

The support system is made up of a rigid backing, with rigid side strips at the top, bottom and sides.

Gator foam, thick plywood—sealed—or thick Masonite are all suitable. Acids are not a problem with opalatypes; but they are photographs, so take care to avoid sulphur-containing materials.



A damaged opaltype.
Photograph courtesy of Artlab Australia, reproduced with permission of Lyn Kilsby



The rigid backing can be seen in the foreground. The bottom side strip is not yet in place.

Photograph courtesy of Artlab Australia



The side strip should be the same depth as the opaltype. A window mount can then be placed over the opaltype.

Photograph courtesy of Artlab Australia

Easy do-it-yourself methods for storing photographs

This section describes:

- methods for protecting individual photographs;

- methods for attaching photographs to album pages so that they can be easily removed without damage; and
- methods for constructing simple albums.

Photographs should be wrapped individually or interleaved if possible. This protects the individual photographs from abrasion, dust and light, and provides the basic layer in a layered storage system.

Making a four-flap wrapper

Mark out with pencil the four-flap wrapper on the material you are using to store individual items.

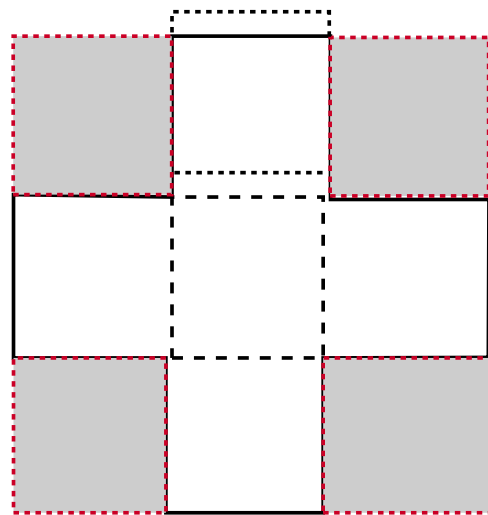

The base of the four-flap wrapper should be slightly bigger than the item, so that the flaps can fold over without bending the edges of the photograph, but not so big that the photograph can move freely within the wrapper.

The flaps are marked out slightly shorter than the base, and tapered from the base to the outside edge—this is not shown in the diagram.

When making a wrapper for thicker items, for example, glass negatives or slides, allow for the thickness or the wrapper will not fit.

Once it is marked out, the wrapper can be cut and the flaps folded over. The dotted line indicates where the wrapper is folded.

The photographic emulsion should be placed face-down on the base, and the flaps folded around the back of the item.



Four-flap wrapper containing a cased ambrotype.
Photograph courtesy of Artlab Australia

Simple wrapper/interleaving method

There are occasions when a simpler wrapper may be more practical. In this case, you can place the individual photographs inside a fold of the material you are using for storage. This method is better than simple interleaving.

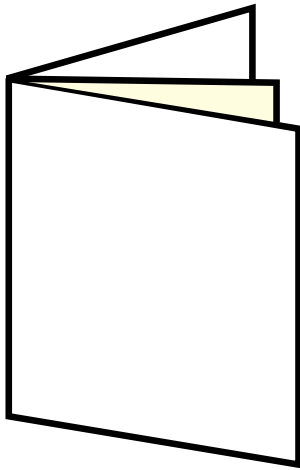

Preferred methods of attaching photographs to album pages

Photocorners: Photocorners are an excellent method of attaching paper items to mounts without using adhesives. They should be made from archival materials—Mylar is particularly suitable.

Cut a strip of Mylar to an appropriate size—15 x 45mm is a good size for small items. Then fold the strip to produce a triangular section in the centre, as illustrated:

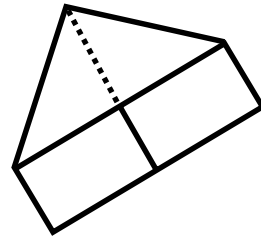

Mylar is difficult to fold and you may need to use a letter opener, a bone folder or the blunt edge of a knife to crease it fully.

Once this is done, place 6mm wide acid-free double-sided tape on the unfolded ends of the photocorner.

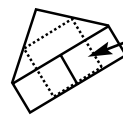

Double-sided tape attached to the back of the Mylar, ready to be attached to the album page

This way, the photocorner can be stuck down to the backing paper and no adhesive touches the items being mounted.

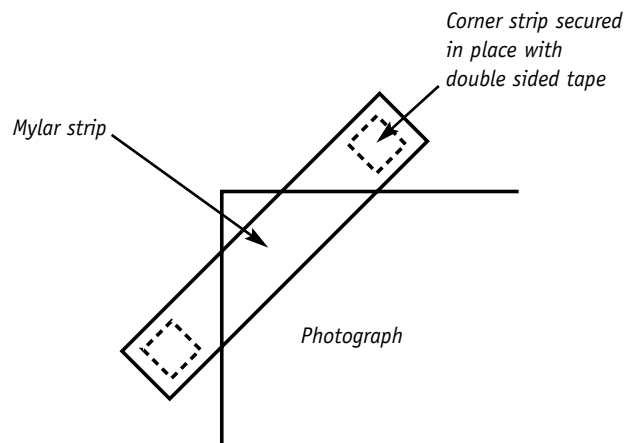
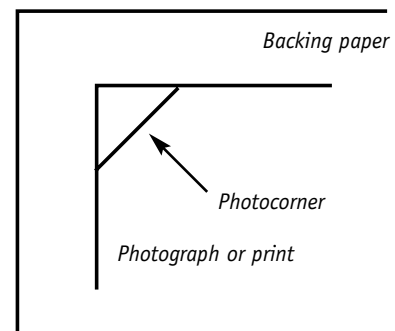

Corner strip secured in place with double sided tape

Slits in the album pages: This technique can also be used for attaching photographs to album pages. Using a double slit, as illustrated, involves much less risk to the photographs than a single slit.

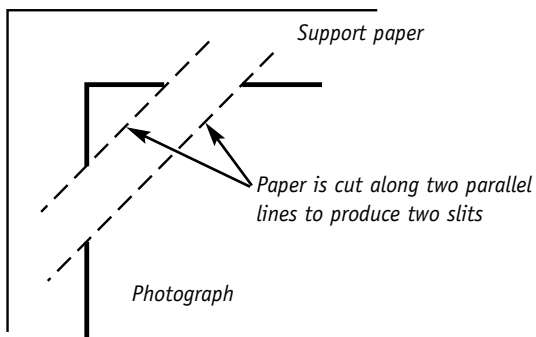

CAUTION:

This method should be used only with paper and should be considered as a last resort, because the corners of the photographs can be creased and eventually break along the line of the slit in the paper backing. This method should never be used with heavy paper or cardboard.

Simple albums

If archival-quality albums are unavailable or unsuitable, or if you would prefer to make your own, you can make an album using a ring binder.

The photographs should be attached to thin acid-free card or medium-weight, acid-free paper by one of the methods outlined above. If you are using the slits in the album pages method of attachment, use paper not card. If you don't have acid-free paper, you can use fresh photocopy paper, but consider this an interim measure only.



Archival-quality photograph albums.

Photograph courtesy of Artlab Australia, albums supplied by Anthony Zammit

Place the photographs on their supporting papers or card in Mylar or Copysafe polypropylene sleeves, which are positioned in the ring binder.

If the albums are to be kept in storage, they should be placed in boxes or wrapped, to prevent dust entering the sleeves.

A word of caution about buying albums

Many commercially available photographic albums are not suitable for the long-term storage of photographic collections. Damage to collections can result from the use of some albums. This section describes some of the factors you need to be wary of.

So-called magnetic albums. Photographs are held in position by placing them on top of parallel lines of pressure-sensitive adhesive on the surface of the album pages. A plastic sheet is then placed over the top of the page containing the photograph.

Pressure-sensitive adhesives are the same as those used on sticky tapes. As these adhesives age, they first become very sticky and are absorbed easily into paper, fabrics and emulsions. In the next stage the adhesive changes chemically and begins to yellow and eventually turns a dark orange.

At this stage the adhesive is almost totally insoluble; and the stains, and sometimes the photographs, cannot be removed. Photographs and papers attached to these album pages develop stripes.

The rigid, cardboard pages of these albums are made from poor-quality paper, which becomes acidic as it ages.

The plastic sheets which cover the pages and photographs are often made from PVC or another plastic which contains chlorine. Remember that PVC can break down in the presence of atmospheric moisture and produce hydrochloric acid. This is a strong acid which will cause irreversible damage to your collections.

The plastic covers on these albums are not archival-quality, and in some cases may be PVC.

Any album with plastic sleeves or plastic covers.

There are tests which can be carried out to identify PVC; but they are destructive and will make you unpopular with shop owners. Instead, try smelling the

album; if you detect a strong smell it could be PVC and should be avoided for use in long-term storage.

Black paper album pages. Many photograph albums have black pages; but remember that black dyes can contain sulphur which reacts irreversibly with silver and can change images. If you are looking for something for long-term storage, try to find out if the albums are archival-quality.

Displaying photographs

Photographs on display can be affected by adverse conditions, just as they are when they are in storage. During display, however, there are added factors which can contribute to the deterioration of collections. These differences will be discussed in the following sections which deal with:

- how light affects photographs;
- the ideal conditions for displaying photographs;
- lighting hints;
- mounting and framing photographs;
- some easy do-it-yourself methods for displaying photographs; and
- the best materials to use for displaying photographs.

How does light affect photographs?

Light is essential in a display environment. But light, especially when it is accompanied by UV radiation, can cause extreme and irreversible damage to many types of photographs. Many components of photographs are adversely affected by light and UV radiation.

Paper can become brittle and yellow, especially if it contains lignin.

Proteins, such as albumen and gelatine emulsions are affected: albumen yellows and gelatine breaks down.

The dyes used in colour photographs fade when exposed to light. Dyes used for tinting many 19th century photographic prints fade very quickly because early synthetic dyes had very poor light-fastness.



Pink dye can still be seen at the lower edge of the image. The dye has faded in all other areas of the photograph.

Photograph courtesy of Artlab Australia, reproduced with permission of Mortlock Library, State Library of South Australia



Faded photograph. Light can have an adverse effect on photographs, contributing to fading and yellowing.

Photograph courtesy of Fred Francisco



Damaged photograph. The paper has become brittle and split.

Photograph courtesy of Artlab Australia, reproduced with permission of Mortlock Library, State Library of South Australia

The worst reaction for historic black-and-white photographic prints on paper is the photochemical breakdown of lignin, contained in some papers. This reaction produces peroxides, which are strong oxidising agents and chemically attack the silver image.

Exposure to light can multiply the adverse effects of poor environmental conditions. Remember that damage caused by light is often accelerated by high relative humidity and temperature.

For more information

For more information about the damage caused by light and UV radiation, please see *Damage and Decay*.

For more information about the chemical deterioration of photographs, please see the section More About Photographs later in this chapter.

Ideal conditions for the display of photographs

Photographs should be displayed in similar conditions to those outlined for their storage; however, there are some differences.

Light is essential in a display environment, but must be set at levels which will not adversely affect the collection. Original historic photographs and colour prints should be considered sensitive to light. Therefore:

- the brightness of the light should be less than 50 lux; and
- the UV content of light should be less than $30\mu\text{W}/\text{lm}$ and no greater than $75\mu\text{W}/\text{lm}$.

Copy photographs and Cibachromes can be illuminated at higher levels.

CAUTION:

All damage caused by photochemical reactions is cumulative and irreversible.

For more information

For more information about measuring the brightness of light and UV content of light, please see *Damage and Decay*.

The ideal storage temperature for photographs is quite low and is often thought to be too cold for the comfort of people visiting or working in the museum, gallery or library. Therefore the compromise temperature for the display of photographs has been set at 21°C.

Relative humidity is in the moderate range of 30–50%RH, with fluctuations kept to a minimum, as for storage.

The control of relative humidity in a display area may be more difficult than in a storage area. Fluctuations in relative humidity are more likely, because of the varying numbers of people visiting the display followed by no people at times when the display is closed.

The emphasis should be on providing a buffer zone between the photographs and the extreme or fluctuating conditions. Display cases and frames provide layers of protection from extreme or fluctuating conditions.

Protect photographs on display from pollutants, dust and insects.

It is important to use appropriate materials and methods when displaying photographs: to ensure the long-term preservation of the collections.

Lighting hints

Photographs are made up of a number of different materials, and lighting levels for display must take into account all those materials. This is why most photographs are considered to be sensitive to light.

As light can be so damaging to photographs it is important to consider carefully the lighting of displays. This section provides some hints of how to minimise damage to items lit for display.

Tungsten incandescent bulbs are the best form of lighting for the display of photographs because they give out very little UV radiation.

Keep the brightness or intensity of the light low, and regulate exposure periods. Less exposure to visible light and the elimination of UV radiation helps prolong the life of photographs.

When displaying photographs, remember that light also affects the paper on which the photographs are printed—except for particular types of photographs such as opal types, which are on glass. Single-layer and two-layer photographs should be displayed in lower lighting levels than those with a three-layer structure. The baryta layer in the three-layer structure protects the paper support

and there is less likelihood of photochemical damage to the paper.

Never display original salted paper prints. They are extremely light-sensitive and can fade badly.

It is recommended that copies be displayed, rather than the originals.

For more information

Information about the layer structure of photographs is given in More About Photographs later in this chapter

Framing and mounting photographs for display

Mounting and framing photographs supports and protects them from extreme or fluctuating environmental conditions, as well as enhancing their appearance.

Mounts/mats

Window mounts/mats prevent direct contact between the surface of the photograph and the glazing. They are also used for aesthetic reasons, providing a border for the image.

It is important to separate the glazing from the photograph because:

- sudden temperature changes can cause condensation on the inner surface of glass;
- if the photograph does not have a window mount, the emulsion can become sticky and stick to the glass; and
- if photographs stick to glass and then dry off, they are extremely difficult and sometimes impossible to separate without damaging the image.

Photographs should be hinged and mounted in the same way as works on flat paper.

If there is enough margin at the edge of the photograph, you can use photocorners to attach the photograph to the mount. This will be easier with modern, colour photographs because many water-based adhesives will not stick easily to resin-coated paper.

If you don't have the equipment to cut window mounts, contact your local framer, who should be able to cut the window for you.

If you are having items mounted and framed by a framer, specify conservation mounting and framing and conservation-grade materials. Not all framers have conservation-grade materials in stock, so give them enough time to order the materials in.

If you would prefer not to have a window mount/mat framing the image, some provision should be made to separate the photograph from the glazing once it is framed. This is usually done with spacers. These can be made with strips of mount board stuck to the inside of the rebate of the frame. They should be cut thin so that they are not visible.

Frames

Frames add to the aesthetic appeal of photographs and provide a solid, protective outer layer for the photographs they contain. This is particularly important if you are dealing with a travelling exhibition; in this case the frames are not only protective but are also much easier to handle than unframed photographs.

Conservation framing is more complex and more expensive than standard framing techniques, but it is the best protection for your collection while it is on display, especially if the photographs are to stay framed for a long time and are part of a travelling exhibition.

There are a number of components in the conservation framing system.

Cross-section of a conservation framing system

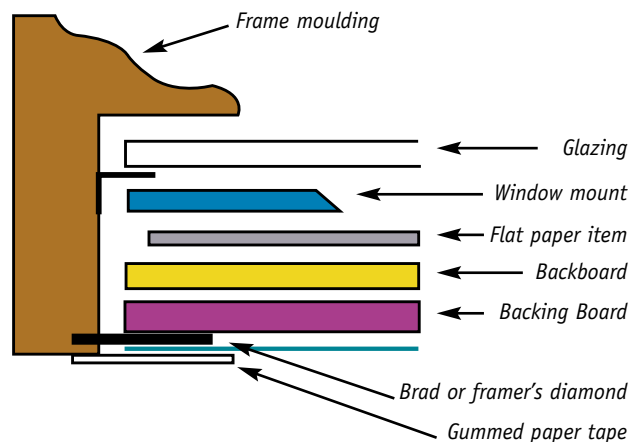

The moulding is usually referred to as the frame. Different types of framing materials will be discussed further in the section *The best materials to use for the display of photographs*

Glazing should provide physical protection to the photograph with a minimum of distraction to viewing. Glass or acrylic sheeting can be used for glazing. Each has advantages and disadvantages:

- glass can break and damage the photograph. It has a slight colour, either a blue or green, which may interfere with the colour-balance in the photograph. This colour becomes more noticeable as the glass ages; and
- acrylic sheeting, such as Perspex or Plexiglas, is prone to scratching, which can be visually disturbing. It can also develop a strong static charge. But acrylic sheeting gives better protection against UV radiation than glass, particularly if a UV-absorbing acrylic is used.

The glazing seal—shown as a rightangle in the diagram—is applied around the edges of the glazing to the rebate of the frame. It stops insects and airborne pollutants from entering through the front of the frame. It also protects the photograph from any chips of glass which may come away from the cut edge of the glass.

Glazing seals are not used universally in conservation framing systems—some argue that they reduce the rate of air interchange between the frame and the outside world.

The moisture barrier—an inert material—for example, Mylar or aluminium foil attached at the back of the frame, reduces moisture migration into the frame. Creating this barrier is important when framing items which are particularly sensitive to moisture: Cibachromes, for example. The moisture barrier is shown between the brad and the gummed paper tape.

The outer tape seal, from the edge of the moisture barrier to the edge of the frame, completely seals the package and stops insects and air pollutants entering the framing system.

Easy do-it-yourself methods for displaying photographs

It is not always appropriate to go to the expense and effort to frame your photographs for display, especially if they are to be displayed only for a

short time. But it is still important to provide protection and support for the photographs. Some alternatives to mounting/matting and framing are:

- displaying your photographs in their polyester or polypropylene storage sleeves; and
- placing the photographs in their storage sleeves in a mount.

With these two methods, you can place the photographs in a display case or attach them to a display board. When attaching them to a display board, make sure:

- the method of fixing the items to the board is secure and will not allow the photographs to fall; and
- it must not damage the photographs or their permanent storage enclosure. For example, pushing pins through the storage sleeves is not recommended, while using double-sided tape on the outside of the storage sleeves would not cause any lasting damage and would be easy to remove if the exhibition was a short one.

When attaching the photographs to a solid support, such as a sheet of conservation mount board cut to an appropriate size, the methods described in the section on storage can be used. Once the photograph is supported adequately, it can be placed in a display case. The solid support performs a number of functions:

- it supports the photograph during handling, that is, when it is being placed in or removed from the display case; and
- it acts as a barrier between the materials of the display case and the photograph.

The best materials to use for displaying photographs

As already discussed in the section on storage, some materials can have an adverse effect on photographs. It is important to select carefully the materials which you are going to use in your display system.

Wrappers, enclosures, mounts and anything which is in direct contact with the photographs should be made from materials that are chemically inert and which will not cause physical damage to the photographs.

Mount/matboard should be conservation-grade: either a 100% rag board or purified wood-pulp—alpha cellulose. These boards have had the lignin and other contaminants removed.

Black-and-white gelatine emulsion photographs can be mounted/matted with board which has a 2% alkaline buffering. Whether a board is buffered or not will be noted in the manufacturer's specification.

Colour prints and cyanotypes should not be mounted on boards which contain alkaline buffers; a photographic-quality mount/mat board would be suitable for these photographs.

CAUTION:

Colour prints may be affected by the presence of alkalis, and should be mounted on non-buffered, acid-free board. The cyanotype is another photographic medium definitely known to discolour in the presence of alkaline buffering materials.

The two most common framing materials are metal and wood.

Metal frames—aluminium section—are ideal for framing photographs because they are:

- physically strong;
- chemically inert, giving off no destructive vapours;
- unaffected by decay, insect or fungal attack;
- the assembly hardware allows them to be opened easily for inspection; and
- the clean, simple mouldings present most photographs to their best advantage.

Wooden frames often look very impressive, especially on historic photographs. But they have characteristics which could make them unsuitable on preservation grounds:

- raw wood gives off peroxides, which are strong oxidising agents and harmful to prints; and
- softwoods, like pine and cedar, contain resins which remain volatile for years and will affect prints adversely.

Basswood and Jelutone are low-resin woods and are considered suitable for preservation-grade frames.

If you are using wooden frames, the rebate should be sealed with polyurethane or acrylic resin varnish to prevent acid vapours from the resins reaching the prints. And remember that even hardwoods contain some resins.

Frames which have been sealed as outlined above, stained or painted should never be used until the paint has cured thoroughly. Dry, but uncured, paint emits vapours known to be particularly harmful to photographic emulsions.

Tapes suitable for use as glazing seals are Filmoplast P90, Tyvek tape, 3M Scotch 810 magic transparent tape and polyester tape 8411.

Tapes suitable for use as outer seal tapes are gummed paper tape, Tyvek tape, 3M Scotch 810 magic transparent tape and polyester tape 8411.

Mylar is suitable for use as a moisture barrier in a conservation framing system and as a storage and display sleeve.

Polypropylene can be used as a display sleeve; but it is not as clear as Mylar and does not look as attractive.

GOOD	BAD
photographic-quality rag and wood pulp papers	poor-quality papers such as newsprint or butchers paper
plastics such as archival-quality polyester and polypropylene	black papers and boards—these often contain sulphur
photographic storage paper	coloured papers and coated papers
photographic, museum or conservation-quality mount board	PVC—polyvinyl—a common plastic
metal furniture with baked enamel finish	furniture made from uncured wood or recently painted furniture

Summary of conditions for storage and display

	Storage	Display
Temperature	18°C ± 4°C	21°C ± 4°C
Relative Humidity	30–50% RH	30–50%RH
Brightness of the Light	Dark storage preferred	Less than 250 lux.
UV Content of Light	Nil	Less than 30 µW/lm and no greater than 75 µW/lm.

Photographs in Australia's climatic zones

The climatic zones outlined below are broad categories. Conditions may vary within these categories, depending on the state of repair of your building and whether or not the building is air conditioned.

Arid

This climate is generally very dry, however, in arid areas it is often very hot during the day and very cold at night. This wide fluctuation in temperature is matched by wide fluctuations in relative humidity, for example from 75%–20%RH in a day.

When caring for photographs in arid areas it is important to note that:

- insects can still survive;
- paper and photographic emulsions tend to give out the water they contain - this can lead to the photographs becoming dry and brittle; and
- as they release moisture at different rates, the paper and emulsion can begin to separate.

Remember that even arid areas can have periods of higher relative humidity, even though the periods may only be very short.

The system of layers of storage—wrappers, boxes, boxes within cupboards—is particularly suited to arid areas because of the tendency to get quite marked fluctuations in temperature and relative humidity. Many arid areas are also very dusty and so the layers of storage protect the photographs from dust and grit.

Because of the large temperature fluctuations in arid areas, there is a risk that condensation could form inside plastic wrappers, leading to sticky emulsion and possible mould growth.

Note: If your photographic collections have been stored in an arid environment for a considerable period and they are stable—**do not** try to alter the environment to meet the recommended ideal conditions. This could do more harm than good. The emphasis should be on long term stability.

Temperate

A temperate climate is considered a moderate climate, however, temperate climates tend to have a greater range of temperatures than tropical climates and may include extreme climatic variations.

- It is probably easier to come close to the recommended ideal conditions for the storage of photographs in a temperate climate, however, it is unlikely that you will be able to maintain an even environment without the help of sophisticated air conditioning equipment.
- The system of layers of storage - wrappers, boxes, boxes within cupboards will be very useful in helping to buffer against the extreme conditions that can occur in a temperate environment.
- As for all climatic areas, regular inspection of storage and display areas is important so that developing problems do not go unnoticed.

Note: If your photographic collections have been stored in a temperate environment for a considerable period and they are stable—**do not** try to alter the environment to meet the recommended ideal conditions. This could do more harm than good. The emphasis should be on long term stability.

Tropical

These climates are characterised by heavy rainfall, high humidity and high temperatures.

When caring for photographs in high humidity conditions it is important to note that:

- insects and moulds thrive and reproduce readily.
- the rate of deterioration due to light and UV radiation increases.
- different components of single objects will take up moisture at different rates and swell by different amounts—this can lead to problems such as emulsions separating from the photographic base paper.
- gelatine emulsions on photographs swell and can readily stick to anything they are in direct contact with.

Remember that in tropical areas, air flow is important and this should be taken into account when designing storage and display systems.

The use of plastic sleeves for storage and display is not recommended in tropical areas, as the sleeves restrict air flow and will prevent damp photographs from drying out.

Note: If your photographic collections have been stored in a tropical environment for a considerable period and they are stable—**do not** try to alter the environment to meet the recommended ideal conditions. This could do more harm than good. The emphasis should be on long term stability.

Some miscellaneous advice

Mechanised processing versus hand processing

Modern photographic processing systems cannot guarantee the same long-term stability as hand processing. However, mechanised processing is much cheaper and more convenient.

If the long-term stability of your colour prints is very important to you, it is wise to have them hand processed by a photographer, or to have them processed with a new batch of processing chemicals.

Cibachromes

Cibachromes are very stable, although they are very sensitive to moisture. If you want a very stable colour print, have a glossy Cibachrome print produced from a slide. Pearl Cibachromes are not as stable.

To laminate or not?

Lamination is sometimes promoted as a way to preserve your photographs, but there are problems associated with laminating photographs.

Once a photograph is laminated, it is virtually impossible to remove the lamination material without damaging the photograph and without using strong chemicals.

The process of lamination can damage the emulsion layer of the photograph; and over time the lamination material, with emulsion attached, will pull away from the paper base of the photograph. This damage is permanent.

Lamination may be suitable:

- if you have the negative and can print more copies of the photograph; and
- you want to protect the photograph in situations where it may get damaged or very dirty.

A reversible alternative is to place it in a Mylar sleeve.

Historic evidence accompanying photographs

Many photographs—particularly older photographs—may come into your collection in their original folder, in a frame or mounted on a card on which the photographer's name and address are printed.

Often these materials are dirty, deteriorating and not good quality. But they should not be discarded because they often provide valuable information about the photographs.

If the accompanying materials are in very poor condition, lightly brush them clean, then wrap, label and store them separately from the photographs.

From the mid-1850s to the early 1900s, cartes-de-visite and cabinet cards were very popular.

Cartes-de-visite are quite small; cabinet cards, which come in a range of sizes, are larger. Both are made up of photographs stuck down to card. These cards are often poor quality and brittle. Despite their poor quality, these cards should not be removed as they are an integral part of these items. A number of books on the history of photography give further details of these popular photographic formats.

Treatment of damaged photographs is not always simple. It is important when treating a photograph to be able to identify the process before determining the treatment to be applied. It is also important to know:

- what materials are likely to have been used. These can vary because many photographers experimented with materials and processes; and
- the particular sensitivities of these materials.

A note of warning about nitrate film stock

A number of collections contain examples of nitrate film, which was used for still film and movie film before the introduction of safety film.

Nitrate films are extremely dangerous. They consist of cellulose nitrate, a very unstable material.

As nitrate film degrades, it produces nitrogen oxide. Further degradation results in spontaneous combustion of the film; and because nitrogen oxide reactions produce oxidising agents, this reaction can occur without the presence of oxygen in the air. This means that degraded cellulose nitrate can burn under water or when smothered with fire-retarding foam or sand. Degraded cellulose nitrate is sticky and smelly.

The National Film and Sound Archive conducted a search for nitrate film in Australian collections in the mid-1990s. If you suspect you have cellulose nitrate in your collection, contact the National Film and Sound Archive, or a relevant State institution for information and advice.

MORE ABOUT PHOTOGRAPHS

A brief overview of the chemistry of photography

Photography—drawing with light—includes any process in which pictures are produced by the action of light on light-sensitive materials.

Light-sensitive materials

Many materials are light-sensitive, but not all are suitable for the production of images:

- some materials fade in light;
- some materials darken in light;
- light causes molecules to decompose in some materials; and
- in other materials, light causes molecules to combine and to create larger molecules.

The most commonly used light-sensitive materials in photography are silver salts.

Light-sensitive silver salts

Silver salts decompose in light to produce metallic silver, which makes up the image. The silver salts which were found to be best for this process were the silver halides—silver chloride, silver bromide and silver iodide.

Initially, prolonged exposures were used to develop images. Negatives were placed in a printing-out frame in contact with sensitised positive papers and then exposed to light. Once the images had developed sufficiently, they were fixed chemically. This was the principle of the printing-out papers.

Developers

There are many advantages to be gained from the use of chemical developers. These include:

- reduced exposure times;
- allowing the photographer much more flexibility in manipulating his/her images; and
- making enlargements, reproductions and mass production of images possible.

With the introduction of developers, the sensitised paper was exposed to light for a shorter period. During this exposure time, an invisible latent image formed. This image was then intensified 109 times using the developer.

Developers are reducing agents, that is, they supply electrons to a system.

A number of reducing agents were tried, but not all were successful. If they are too strong they reduce all the silver halide to metallic silver—even the silver halide which has not been exposed to light. If too weak, they will not develop the image enough.

Much of the work done before a suitable process was found was experimentation—to find developers which had enough power to reduce the exposed silver halides, but not enough to reduce those that had not been exposed to light.

Fixers

If photographic images are not fixed, the chemical reactions will continue—leading to loss of image. Once the image has developed, the silver halides which have not been exposed to light must be removed from the system. Fixers are chemicals which dissolve silver halides and remove them from the system.

The fixer and dissolved silver halides must be washed away. Retention of these within the system will lead to discolouration.

Emulsions

Emulsions were produced from:

- albumen—egg white;
- cellulose nitrate—called collodion in this application; and
- gelatine.

Emulsions coated onto the photograph base-paper, glass or metal:

- allowed an even spread of the light-sensitive salts over the base material;
- provided a smoother surface than the surface of uncoated paper, giving more sharply focused images; and
- could be applied in liquid form and then dried in a thin film.

Gelatine

Gelatine survived as the most popular and widespread emulsion material. This is because gelatine has properties which make it particularly suitable for use in photography:

- gelatine is soluble in warm water, but remains as a gel in cold water. This allows water-based processing of the image without loss of emulsion. It is important to note that old degraded gelatine may be soluble in cold water;
- gelatine can be treated with formaldehyde to harden it, so that it is no longer soluble in hot water;
- gelatine contains minute amounts of materials which increase the sensitivity of the silver halides to light. This is due to the eating habits of cows, which are the source of the gelatine. Cows like hot-tasting food, which contains sulphur. Rabbits, on the other hand, do not like hot food and their gelatine is less suitable.

CAUTION:

While minute traces of sulphur in a properly formulated emulsion can be beneficial, sulphur is not good for photographs because it reacts irreversibly with silver.

A brief overview of photographic deterioration mechanisms

There are two main mechanisms of deterioration: sulphiding and oxidation-reduction deterioration.

Sulphiding

Silver has a strong tendency to react irreversibly with sulphur. The product of this reaction is silver sulphide—a black material that appears yellow when it is in very small particles. The main sources of damaging sulphur are:

- hydrogen sulphide from atmospheric pollution.
- inadequate washing after fixing. It is virtually impossible to remove all the fixer as it is retained tenaciously by paper fibres and baryta coatings. Fixer—sodium thiosulphate—breaks down in the presence of moisture and releases reactive sulphur.

Both of the above cause yellowing, fading and loss of detail in the highlight areas. Eventually the whole image is affected and will fade and change colour.



The highlight areas of this print show fading and loss of detail due to sulphiding.

Photograph courtesy of Fred Francisco

- use of exhausted fixer baths. Thiosulphates combine with silver ions; many of the resulting molecules are soluble and so the fixer and excess silver can be washed away. If the bath is exhausted, insoluble molecules can form; these are retained by the gelatine. So there are sulphur and silver ions still in the system. The silver reacts to become metallic silver, causing yellowing. Non-image

areas change in colour: from white, to yellow then brown.

High relative humidity accelerates sulphiding.

Oxidative-reductive deterioration

This is the most important deterioration mechanism for silver-based images. The main mechanisms and their effects are:

- metallic silver particles are oxidised to produce silver ions;
- while metallic silver is coloured and therefore makes up the image, silver ions are colourless and do not absorb light;
- as ions have an electric charge, they can move around the system. They can migrate to the surface where they are reduced back to metallic silver, creating the characteristic mirroring or silvering out; and
- they may also migrate within the system and then be sulphided.



Silvering out around edges of a photograph.

Photograph courtesy Artlab Australia, reproduced with permission of Ann V. Nicholas

Oxidative-reductive deterioration can also cause loss of highlight detail, overall fading and colour shifts to warmer hues.

Images developed using chemical developers are less vulnerable to this deterioration than those on printing-out papers, because the silver particles in developed images are bigger.

Only minute quantities of oxidising agents are required to cause deterioration and there are many oxidising agents in atmospheric gases and pollutants.

Controlling temperature and relative humidity helps slow down the process.

For more information

For more information about adverse environmental effects, please see *Damage and Decay*.

Layer structures for various photographs

Single-layer structure, as for salted paper prints, cyanotype, platinotypes. The light-sensitive material is within the paper.

Two-layer structure, as for albumen prints, carbon prints. The light-sensitive material is in the upper emulsion layer. The lower layer is the paper.

Three-layer structure, as for gelatine and collodion printing-out papers and gelatine developing out papers. The light-sensitive material is in the upper emulsion layer. The middle layer is the baryta layer, which gives a very smooth, white surface on which the emulsion layer rests. It is opaque and hides the irregular surface of the paper fibres. The lower layer is the paper.

The structure of modern, resin-coated paper. The centre layer is the paper core. Either side of this is a layer of polyethylene. The light-sensitive gelatine emulsion is on the top. There is also a gelatine backing layer at the base.

A brief history of the development of photography

In a relatively short period photography has grown from a process still in its experimental stages to one that is well established and widely used.

The evolution of photography is not simple and straightforward; it is the result of the efforts of many people working in a great range of disciplines. The following notes give a brief summary of the main contributors and the milestone discoveries.

Beginnings

Well before the beginning of the 19th century, much of the equipment and knowledge necessary for the eventual appearance of photography were available.

The camera obscura had been known since at least 1038, when it was described by Ibn Al-Haitham. It was not until the 17th and 18th centuries that its use became widespread.

The study of photochemistry was a by-product of research into other areas and it was known that:

- the action of light alone caused silver salts to darken (Schulze, 1727);
- further work, using silver chloride, established that violet light caused silver salts to darken far more rapidly than longer wavelengths of visible light (Scheele). Where it took fifteen seconds for silver chloride to darken when exposed to violet light, it took up to twenty minutes to darken to the same degree when exposed to red light (Senebier, 1782).
- silver chloride, which had darkened under the action of light, was insoluble in ammonia. The darkened substance was, in fact, metallic silver (Scheele); and
- some resins became insoluble in turpentine after exposure to light (Senebier).

At the beginning of the 19th century, a number of people began to see that it might be possible to obtain a permanent image using the camera obscura and light-sensitive materials.

Thomas Wedgwood and Sir Humphry Davy did some early work on this. They produced images by placing items on sensitised paper and leather and then exposing them to light, but were unable to fix the images.

For more information

For more information about the different wavelengths of light, please see the chapter on Light and Ultraviolet Radiation in *Damage and Decay*.

The first photograph

In 1816 in France, Nicéphore Niépce produced a negative image using paper sensitised with silver chloride and placed in a camera obscura. But he failed to fix the image.

He produced a permanent image in 1822, using bitumen of Judea, which hardened when exposed to light. An engraving, made transparent with oil, was placed over a glass plate coated in the bitumen. After several hours' exposure to light, the unexposed areas of bitumen could be dissolved in lavender oil—a light petroleum oil—leaving an image formed by the hardened bitumen of Judea.

In 1827 Nicéphore Niépce became the first person to produce a direct positive photograph from nature. He called the image a heliograph. He had used a bitumen-coated pewter plate which he had placed in a small camera obscura and exposed for about eight hours.

The daguerreotype and the calotype

Photography was announced to the world in 1839. There were two processes employing slightly different manipulations of light-sensitive silver salts.

Daguerre announced his discovery in January 1839 and presented the details of the process to the world in August 1839.



Daguerreotype image.

Photograph courtesy of Artlab Australia, reproduced with permission of Art Gallery of South Australia

A silver-plated copper sheet was exposed, first to iodine vapour to sensitise it, then to light, and finally to mercury vapour which developed the latent photographic image. The image was then fixed with sodium thiosulphate solution, washed and gently dried over a flame.

The image, a fine amalgam of silver and mercury, had to be protected from abrasion and oxidising agents, and was framed and enclosed in a case.

The daguerreotype was an immediate success, but it had two disadvantages:

- it was difficult to see: and,
- each daguerreotype was a one-off and could not be used to produce copies.

In 1839 William Henry Fox Talbot prepared his *Account of the Art of Photogenic Drawing, or the process by which natural objects may be made to delineate themselves without the aid of the artist's pencil*. This described how he sensitised paper by brushing it with silver nitrate and then sodium chloride. After exposing the paper to light for about two hours in the camera obscura, the image which formed in the paper was fixed using a concentrated sodium chloride solution. By late 1840, Fox Talbot had made significant improvements to his process.

He produced an *iodised paper* by coating writing paper with silver nitrate solution and then—before it dried—immersing it in potassium iodide solution, thus forming silver iodide in the paper. This paper could be stored for an indefinite period in the dark.

For use, the paper was washed with Fox Talbot's *exciting liquid*, then exposed for less than a minute, after which it was brushed again with the *exciting liquid*. The second application of *exciting liquid* developed the latent image. The photograph was then washed and fixed. This produced a negative image, which was then waxed to make it transparent.

By exposing sensitised paper in contact with the negative, positive images could be produced. This was the calotype process.

The calotype process formed the base from which modern photography evolved.

Its greatest advantage was that it was a two-stage process. Where previously a negative image had been a disappointment to the experimenter, it was now seen as the means with which to produce multiple positive copies.

Albumen paper and the wet collodion process

By the early 1850s most of the teething troubles of photography had been eliminated; and it was from this time that photography really flourished. In 1850 and 1851 two important improvements to photography were published: the albumen printing-out paper and the wet collodion process.

Albumen printing-out paper was introduced in 1850 and it became the most important print material of the 19th century.



Albumen print.

Photograph courtesy of Fred Francisco

Albumen was prepared by beating egg-white until it was very frothy, and then leaving it to settle to a liquid. Most manufacturers allowed the albumen to ferment, because this improved the final print quality. Very thin rag paper was coated by floating it on top of an albumen and sodium chloride mixture. Before use, the paper had to be sensitised. This was done by floating the paper on a solution of silver nitrate.

For printing, the sensitised paper was placed in a frame in contact with the negative and exposed for periods ranging from a few minutes to a number of hours. Once the image had appeared, it was fixed.

Various improvements were made to albumen paper between 1850 and 1900. These include:

- the introduction of gold toning for use with albumen paper. This changed the image's colour from a red-brown to a warm purple-brown or blue-black, and improved the stability of the image;

- from the late 1880s platinum toning was also used, usually in combination with gold toning: it gave the image a nearly neutral tone. Platinum toning on its own turned the image brown;
- from 1863 dyes were added to the paper base to counteract the yellowing of the albumen layer. Pink was the most common dye; but green, blue and violet were also used; and
- ready sensitised albumen paper became available in the 1870s. The use of citric acid in the preparation of the paper gave it a shelf-life of several months.

The wet collodion process was announced by Frederick Scott Archer in 1851. This used glass as the carrier for the negative image.

Collodion, containing potassium iodide, was poured over the glass to form a thin, even film. This was immediately sensitised with a silver nitrate solution. The plate had to be exposed while still wet, and then developed with pyrogallic acid.

Sodium thiosulphate or potassium cyanide were used to fix the image, which was then washed and dried. Then the plates were often warmed to receive a protective varnish before any positive prints were made.

It was not an easy process. All the processes described above were done by hand. And if photographs were to be taken outside, a portable darkroom, complete with all chemicals, water and equipment, had to be carried.

Some of the chemicals were toxic, for example, potassium cyanide was used for fixing and for cleaning excess developer off the equipment.

The wet collodion process was extremely popular. The advantages of fine detail, improved tonal ranges and reduced exposure times, plus the fact that the process was not protected by patent, outweighed the disadvantages.

Collodion on glass negatives and albumen-coated paper positive prints were such a successful combination that they dominated photography for over 30 years.

Gelatine dry plates and film negatives

From the 1870s the use of dry gelatine plates became common; and then in the late 1880s film negatives were introduced.

The gelatine dry plate was put forward by Dr R.L. Maddox in 1871. Two years later, ready-coated plates were available.

Glass plates were machine-coated with gelatine containing light-sensitive silver bromide.



Glass plate negative.

Photograph courtesy of Fred Francisco

The plates did not need any processing to sensitise them before use; they could be stored for many months and required much shorter exposure times than previous methods.

The first film negatives, introduced in the United States in 1888, were made from cellulose nitrate. This was extremely flammable and was gradually phased out in favour of safer film materials.

Collodion and gelatine emulsion papers

Not long after the introduction of collodion and gelatine as emulsions in negative processes, they were applied to paper for the production of positive photographic prints. In these processes the gelatine or collodion emulsions contained the light-sensitive silver salts when they were coated onto the paper. These photographic papers are called emulsion papers.

Collodion printing-out papers became available in 1867. The papers had a barium sulphate layer—the pigment baryta—between the paper and the

emulsion, to overcome the problem of the collodion not sticking to the paper. The collodion contained silver chloride and citric acid.

Gelatine printing-out papers became available in the late 1880s.

The only difference between the two types of paper was in the nature of the binder, i.e. collodian or gelatine:

- they were both exposed to daylight in printing-out frames and processed in the same way;
- they both produced reddish-brown to purple-brown image colours; and
- photographs which were double-toned with gold and platinum tended to be neutral. Some papers were self-toning, that is, the necessary salts were contained in the emulsion and were released during fixing.

Most photographic papers after this time had a three-layer structure. The baryta layer produced a very smooth, opaque, white surface on which to coat the emulsion. The image quality was improved as the underlying paper fibres were masked and final image contrast was heightened. The emulsion layer was protected from chemically active substances which might have been present in the paper.

Developing-out papers

Chemical development of positive images was used as early as 1851 by Blanquart Evart in his commercial photographic printing firm. But development was not commonly used until the 1880s, when the materials of the gelatine dry plate method were applied to production of positive prints.

From about 1885, papers coated with gelatine containing silver bromide became available. At first the emulsion was coated directly onto the paper; after 1895 bromide developing-out papers were also coated with a layer of barium sulphate.

Silver bromide and gelatine emulsions were sensitive enough to allow enlargement of negatives.

Bromide developing-out papers produced neutral, black images with improved image stability. This

was largely due to the structure and shape of the silver formed by the development process.

Developed images have much larger silver particles than printed-out images. Chemical development of positive prints produces filamentary silver, which is deposited as long, twisted strands. It is these larger, irregularly shaped silver particles that give neutral-toned images greater chemical stability

In printed-out papers the images are made up of small spherical particles of silver called photolytic silver. The particle size is directly proportional to the amount of light received during exposure. Photolytic silver produced warm-toned images, tending toward reds, browns and yellows. These small particles are very vulnerable to the chemical activity which results in image deterioration.

Chemical development of positive photographic images was the way forward for modern photography. In the first decade of the 20th century developing-out papers began to take over from printing-out papers.

Colour photography

From the early beginnings of photography, there was a desire to produce colour images. But it was some time before any practical systems of colour photography were available and it was many years before colour photography became the norm.

A number of different systems for producing colour images were tried. Many fell by the wayside, while others were altered in minor ways over many years to produce better colour and better quality images.

A full description of the developments is not necessary in such a brief history of photography, so only a few of the developments are listed below. These give some idea of when these developments took place in relation to the development of black and white photography.

In 1903 the Lumière brothers invented and patented the Autochrome process, the first practical system of colour photography. It was a coloured transparent image on glass.

A silver-gelatine emulsion was exposed through a screen of potato starch grains dyed orange, green and violet. After reversal processing, a positive silver image was produced which, when viewed through the colour screen, reproduced the original colours.

Autochrome plates were produced in large quantities between 1907 and 1940.

The Tricolor Carbro—invented in 1905—was used commercially for the first time in 1919. Carbro prints were made by placing three carbon images, coloured with pigment, onto paper. The risk of fading was reduced by the use of pigments instead of dyes.

In 1935 Kodak Kodachrome was introduced. It was first a movie film, then introduced as a 35mm slide film the following year. Other film companies followed with their own colour films.

In 1939 the Diffusion Transfer process was invented. Initially it was intended as a method of rapid document copying. Now it is used in instant-picture cameras.

In 1941 Minicolor prints, made from Kodachrome slides, were made available for the first time.

Kodacolor, a method for producing colour prints from negatives was introduced in 1942.

In 1944, Kodak introduced the Dye Transfer technique. It largely supplanted Tricolor Carbro. It was used primarily by studio photographers or serious artists.

By this time the major hurdles in the development of colour photography had been overcome; from then on, many minor developments were made, resulting in the processes with which we are familiar today.

Identification of historic photographs

The wide range of materials used in producing photographic images has led to a wide range of deterioration patterns. This means that some historic photographs need to be treated differently to others. For example, it is recommended that original albumen prints are not exhibited at all—copies should be made for exhibition. Carbon prints, however, can be exhibited safely if standard exhibition precautions are taken.

Correctly identifying the process is important. In many cases the deterioration pattern can help identify the process used.

Daguerreotype: 1839–c1860

Structure. The daguerreotype consists of a positive image formed by mercury vapour on a highly polished coating of silver on a copper plate. It is usually in its own decorative and protective case.



The Daguerreotype is in the centre of the bottom row. On either side of it and above it are the components of the case.

Photograph courtesy of Artlab Australia, reproduced with permission of the Art Gallery of South Australia

Appearance of image. The daguerreotype has a silver, mirrored surface. The image changes from positive to negative depending on the viewing angle. This is the main key to identification.

Deterioration. Tarnishing is the most common problem and can cover the entire surface of the plate.

Copper corrosion can occur, where the fractured silver layer exposes the underlying copper layer, leaving behind green and blue copper salts.

Black spots and accretions are sometimes found over the plate. Evenly distributed spots may be the result of residues from the original processing.

Another potential problem is the large needle-shaped silver sulphide crystals which are formed within deeply tarnished films.

Flaking, usually around the edges, is often the result of excessive gold toning.

Ambrotypes: 1851–c1880s

The ambrotype is a variant of the wet collodion process.



A cased ambrotype.

Photograph courtesy of Artlab Australia, reproduced with permission of the Art Gallery of South Australia

Structure. The ambrotype is an under-exposed collodion emulsion on glass. It appears as a negative until a black backing turns the image into a positive.

Ambrotypes usually have their own decorative and protective cases.

Appearance of image. The ambrotype has quite low contrast—the whites appear as dull grey and detail is less visible in the shadow areas. It can be viewed from all angles.

Deterioration. The collodion emulsion may weaken, crack or flake. It may also separate from the glass.

Decomposing collodion releases gases, such as nitric oxide and nitrogen oxide, which combine with atmospheric moisture to form nitric acid—this attacks the cellulose in the collodion.

Atmospheric pollutants and residual processing chemicals can cause the collodion image to deteriorate.

Silver sulphiding will appear as red and green discolouration.

The glass support can break and glass splinters can scratch the emulsion.

If the ambrotype is varnished, UV radiation may cause discolouration and yellowing of the varnish.

The painted black backing often flakes off, leaving what appear to be holes in the image.



This ambrotype had a flaking black backing. This photograph was taken during conservation treatment. The photograph is intact—the area on the right has had the black backing removed. After the flaking backing has been fully removed, it will be replaced with black cardboard and the image will be clearly visible.

Photograph courtesy of Artlab Australia, reproduced with permission of the Art Gallery of South Australia

Tintype, ferrotype, melainotype: 1854–c1930s

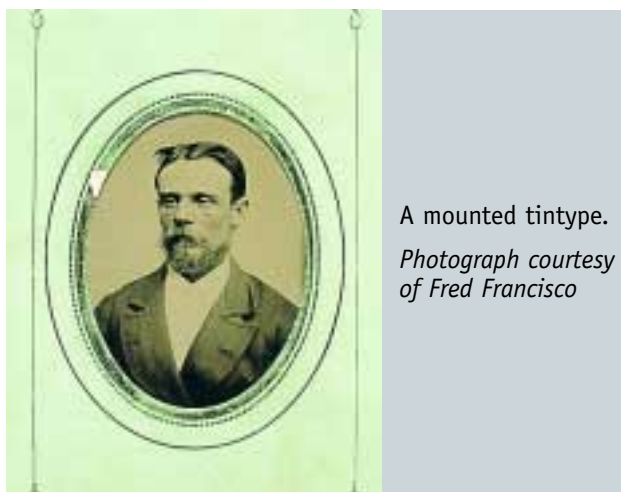

A mounted tintype.

Photograph courtesy of Fred Francisco

Structure. The tintype was a variation on the ambrotype and was a method for making direct, positive images in the camera on a black or chocolate-brown, enamelled iron plate.

The plates were originally coated by the wet collodion process; but dry plates were later manufactured.

Unmounted tintypes are easily identified by their iron base.

Appearance of image. Tintypes have little contrast. Whites appear as dull grey and shadow areas have little detail.

Deterioration. The collodion emulsion may become weak, crack or flake. It may also separate from the plate.

Decomposing collodion releases gases, such as nitric oxide and nitrogen oxide, which combine with atmospheric moisture forming nitric acid—this attacks the cellulose in the collodion.

Atmospheric pollutants and residual processing chemicals can cause the collodion image to deteriorate.

The iron support may bend or be deformed, cracking the collodion emulsion. This often occurred because many tintypes were sent through the mail.

Thin lines of rust can be seen under raking light on some tintypes.

Opaltypes: c1890s

The opaltype is a photographic image on opaque white glass.

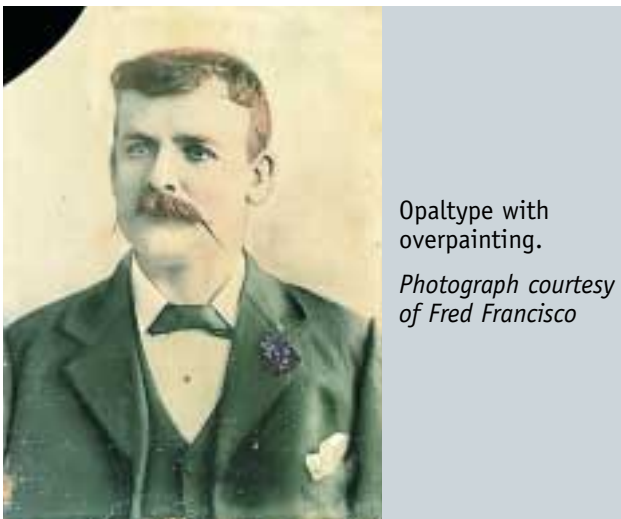

Opaltype with overpainting.
Photograph courtesy of Fred Francisco

Structure. The photographic image is on an opaque white glass.

The base image is usually black and white, but often heavily overpainted.

Overpaint is smudged when attempts are made to dust or clean the image.

Deterioration. The glass support often breaks, and there can be subsequent loss of image from chipping along the break.

Overpaint is smudged when attempts are made to dust or clean the image.

The overpaint can become quite dirty and/or stained.

IMPORTANT: The overpaint is usually very soluble in water—don't attempt to clean the surface.

Salted paper prints: developed 1839, widely used 1860–c1890

Structure. One-layer structure—the visible image is formed directly in the paper. The light-sensitive material is embedded in the paper.

Appearance of image. The image is reddish-brown, purple or yellow-brown when processed properly; it can be lilac, pale-blue or a lemon yellow if improperly processed.

The paper fibres are clearly visible under magnification.

Deterioration. The paper used in salted paper prints is susceptible to the same sorts of deterioration as other papers—it becomes brittle, stained and acid burnt.

The prints fade quickly because of improper processing, atmospheric pollution, poor-quality adhesives and mounting materials, resulting in:

- variations in colour;
- edge fading; and
- small yellow dots and lack of highlight detail.

Exposure to UV radiation for prolonged periods causes severe fading.

Platinotypes: 1880–c1930

Structure. Platinotypes have a one-layer structure.

Appearance of image. Platinotypes have a very stable image: there is no fading or silvering out. They are silvery-grey in colour, with a matt surface.

The paper fibres are clearly visible under magnification, and give a rich, velvety texture.

Deterioration. The image, itself, is stable with no fading or silvering out. The processing includes acidic cleaning baths, which contribute to the deterioration of the paper.

Platinum prints are brittle, often with cracked or broken corners.

Residual iron salts plus the acids which are present, contribute to the eventual discolouration of the paper.

Cyanotypes: used c1885–c1910, very rare 1842–1880

Structure. Cyanotypes have a one-layer structure.

Appearance of image. Cyanotypes have a uniform, bright blue image. The surface is matt, with the paper fibres clearly visible under magnification.

Deterioration. The paper used in cyanotypes is susceptible to the same sorts of deterioration as other papers—it becomes brittle, stained and acid burnt.



A cyanotype showing the characteristic, blue image colour.

Photograph courtesy of Fred Francisco

The blue image fades but can be partially restored by storing it in the dark.

IMPORTANT: Alkaline conditions will fade the blue image; therefore alkaline-buffered enclosures should not be used with cyanotypes.

Albumen printing-out papers—POP: 1850–c1890

Structure. An albumen print is a two-layer system, with an albumen layer holding the sensitised silver on top of a paper support.

Appearance of image. Albumen prints generally produce detailed images.



An albumen print with characteristic fading of the image.

Photograph courtesy of Fred Francisco

It is possible to see the paper fibres through the binder layer in highlight areas, when examined under magnification.

Albumen prints can be warm red-brown, a yellow-brown, purplish-brown or purplish-black. Most albumen prints are yellow in the highlight areas.

Deterioration. Typical damage includes fading, yellowing of highlight areas, brittle paper and cracking of the albumen.

Oxidative-reductive deterioration of gold-toned, photolytic silver images results in loss of detail in highlight areas, overall fading of the image and a change in image colour from purplish-brown to warmer, yellower hues.

Sulphiding deterioration, resulting from thiosulphate retained after insufficient washing or from contamination by sulphur in atmospheric pollutants, causes the image to fade to a yellow-brown or to a greenish colour. In some cases, the retention of silver thiosulphate due to the use of exhausted fixer baths, results in the image fading to a greenish-black colour. There is much more staining, usually greenish-yellow, in non-image areas.

Tinting dyes, added to albumen to counteract the warm tones of the image, are extremely unstable and fade readily. High temperatures and relative humidity will also adversely affect these dyes.

Structural problems lead to severe cracking of the albumen layer.

Yellowing of the albumen layer is caused by a protein-sugar reaction. Storage and display conditions are critical in controlling the rate of this reaction, and therefore the extent of yellowing. The key environmental factors are relative humidity, and exposure to UV radiation and to visible light.

Gilt inks were often used in association with albumen prints on cartes-de-visite. These inks, made with bronze powder and zinc, flake quite readily. When the flakes come into contact with the image, they cause local discolouration and spotting of the photographic image.

Albumen prints have a strong tendency to curl when they are not stuck down to a backing.

Collodion printing-out papers—POP: 1880–c1910

Structure. Collodion papers are a three-layer system with the paper support, a baryta layer over the paper—completely hiding the paper fibres—and the collodion emulsion layer on top of the baryta layer.

Appearance of image. The colour of a collodion print varies, depending on the halide salts and toners used during processing.

Glossy collodion prints were usually gold-toned and had a warm tone.

Matt collodion prints were usually gold and platinum-toned and had an olive-black tone. Matt prints were also more stable and resisted fading.

Pigments or dyes were sometimes added to the baryta layer of collodion papers, to make them appear reddish or bluish in colour.

Deterioration. The collodion layer is not flexible. Movement in the paper support due to changes in relative humidity causes hairline cracks to appear in the surface. But, unlike albumen prints, these hairline cracks do not become larger.

Poor storage and handling are serious problems, because the emulsion layer is extremely thin and has very poor resistance to abrasion.

For glossy, gold-toned prints, oxidative-reductive deterioration includes loss of highlight detail, a shift in image colour from purple to warm, reddish-brown and overall fading. Image deterioration is often accompanied by silver mirroring—silvering out—and abrasive damage.

Matt prints are much more stable and show less fading, mirroring and colour change.

Sulphiding deterioration includes fading of the highlights and an intermediate stage of blackening of the image in the middle tones and shadows, followed by fading of the image to a yellowish or greenish-brown.

Matt collodion prints are less affected by sulphiding than glossy collodion prints.

CAUTION:

Never use alcohol on collodion—
collodion is soluble in alcohol.

Gelatine developing-out papers—DOP: 1880–present

Structure. Gelatine prints have a three-layer system, with the paper support, a baryta layer over the paper—completely hiding the paper fibres—and the gelatine emulsion layer on top of the baryta layer.

Appearance of image. The paper fibres are not visible through the binder layer.

Gelatine developing-out papers have a near-neutral image colour: a soft slate-grey which sometimes has a greenish-grey cast.



Silver gelatine
print—a chemically
developed image.

*Photograph courtesy
Artlab Australia,
reproduced with
permission of
G.M. Thompson*

Print surface may be glossy or matt.

Deterioration. The most common types of image deterioration are caused by oxidative-reductive reactions, resulting in:

- overall fading;
- loss of highlight detail;
- yellowing in the lighter areas of the image, fading of lighter tones and overall fading; and
- silver mirroring—silvering out—in shadow areas. Nearly all 19th century gelatine developing-out prints are affected.

In advanced cases of oxidative-reductive deterioration, the original black image colour fades to yellow-brown with yellow highlights. These colour changes are caused by physical changes in the filamentary silver on a sub-microscopic level.

Sulphiding: the symptoms of sulphiding resemble those of oxidative-reductive deterioration.



A silver gelatine print showing overall fading of image.
Photograph courtesy Artlab Australia, reproduced with permission of B. Pring



Silver gelatine print with silver mirroring—silvering out—around the edges of the photograph.

Photograph courtesy of Artlab, reproduced with the permission of Ann V. Nicholas

If you have a problem related to the identification, treatment, storage or display of photographs contact a conservator. Conservators can offer advice and practical solutions.

For further reading

- Baldwin, Gordon 1991, *Looking at Photographs: A Guide to Technical Terms*, The J. Paul Getty Museum, Malibu, California.
- Buckland, Gail 1980, *Fox Talbot and the Invention of Photography*, University of Queensland Press, St Lucia.
- Cato, Jack 1985, *Conservation of Photographs*, Eastman Kodak Company, Rochester, New York.
- Colligan, Mimi 1991, *In Focus—150 Years of Australian Photography*, Griffen Press, generated by Australia Post Philatelic Group, Adelaide.
- Coote, Jack H. 1993, *The Illustrated History of Colour Photography*, Fountain Press, Surrey, England.
- Crawford, William 1979, *The Keepers of Light*, Morgan & Morgan, Dobbs Ferry, USA.
- Daniels, Patrick 1978, *Early Photography*, Academy Editions, London.
- Davies, Alan & Stanbury, Peter 1985, *The Mechanical Eye in Australia—Photography 1841–1900*, Oxford University Press, London.
- Eastman Kodak Company 1985, *Storage & Preservation of Microfilms*, Eastman Kodak Company, Rochester, USA.
- Eaton, George 1957, *Photographic Chemistry*, Morgan & Morgan, Dobbs Ferry, New York.
- Eder, Joseph Maria 1978, *History of Photography*, Dover Publications, New York.
- Ehrlich, Richard 1984, *Dictionary of Photography*, Longman Group Ltd, Harlow, Essex.
- Focal Press, 1974, *Colour Prints: The Photographic Technique of the Colour Positive*, Focal Press, London.

- Focal Press 1993, *Making Kallitypes—A Definitive Guide*, Focal Press, Butterworth-Heinemann, Boston.
- Focal Press 1983, *Storing, Handling and Preserving Polaroid Photographs: A Guide*, Focal Press, Publication Department of Polaroid Corporation, Boston.
- Freeman, Michael 1985, *Instant Film Photography—A Creative Handbook*, MacDonal & Co., London.
- Frost, Lenore 1992, *Dating Family Photographs 1850–1920*, Lenore Frost, 8 Cliff Street, Essendon, Victoria.
- Gernsheim, Helmut 1982, *The Origins of Photography*, Thames & Hudson Ltd, London.
- Gilbert, George 1980, *Photography: The Early Years—A Historic Guide for Collectors*, Harper & Row, New York.
- Hawkins, G.L., 1933, *Pigment Printing—The Bromoil Process from the Negative to the Transfer*, Henry Greenwood & Co. Ltd, London.
- Institute of Australian Photographers 1979, *The Story of the Camera in Australia*, Institute of Australian Photographers, Melbourne.
- Jeffrey, Ian 1981, *Photography—A Concise History*, Thames and Hudson, London.
- Keefe, Laurence E. & Inch, Dennis 1990, *The Life of a Photograph*, Butterworth Publishers, Stoneham, M.A.
- Kraszna-Krausz, A., ed. 1965, *The Focal Encyclopedia of Photography*, Focal Press Ltd, London.
- Martin, Elizabeth & Ride, Peter, 1988, *Collecting and Preserving Old Photographs*, William Collins Sons & Co. Ltd, London.
- McDonald, John & Cole, Melba Smith 1981, *How to Make Old Time Photos*, Tab Books Inc., U.S.A.
- Miller, Russell 1974, *Click*, Marshall Cavendish, London.
- Permutt, Cyril 1986, *Collecting Photographic Antiques*, Patrick Stephens Ltd, Wellingborough.
- Reilly, James M. 1986, *Care and Identification of 19th Century Photographic Prints*, Eastman Kodak Company, Rochester, New York.
- Rempel, Siegfried 1987, *The Care of Photographs*, Lyons and Burford Publishers Inc, New York.
- Richter, Stefan 1989, *The Art of the Daguerreotype*, Penguin, London.
- Ruby, Jay 1995, *Secure the Shadow—Death and Photography in America*, the MIT Press, London, Massachusetts, USA.
- Stroebel, Leslie D. & Zakia, Richard D., eds. 1993, *The Focal Encyclopedia of Photography* 3rd ed., Butterworth-Heinemann, Boston.
- The Editors of Time-Life Books 1973, *Caring for Photographs*, the editors of Time-Life Books Inc, U.S.A.
- Victoria and Albert Museum 1983, *A Guide to Early Photographic Processes*, Victoria and Albert Museum, London.
- Wall, E.J. 1902, *Carbon Printing*, Hazel, Watson & Viney Ltd., London.
- Wilhelm, Henry 1993, *The Permanence and Care of Colour Photographs: Traditional And Digital Colour Prints, Colour Negatives, Slides and Motion Pictures*, Preservation Publishing Company, Grinnell, Iowa.
- Willis, Anne-Marie. 1988, *Picturing Australia—A History of Photography*, Angus & Robertson, London.

Self-evaluation quiz

Question 1.

The causes of damage to photographs can be broadly divided into two categories—physical damage and chemical damage. Name three examples of each.

Question 2.

If you must handle photographs, you should:

- a) handle them as little as possible;
- b) wear cotton gloves or surgical gloves;
- c) always have clean hands;
- d) place the photographs on rigid supports;
- e) all of the above.

Question 3.

When labelling photographs you should:

- a) use biro or felt tip pen;
- b) label each photograph on the edge of the back of the print, using a soft pencil and minimum pressure;
- c) attach a paper label to the photograph using a paper clip;
- d) press hard to make sure the label can be seen.

Question 4.

If you have a damaged photograph you should:

- a) place it in a protective sleeve or wrapper;
- b) mend it with sticky tape;
- c) seek the advice of a conservator;
- d) use rubber cement to stick it to an album page.

Question 5.

What are the ideal temperature ranges and relative humidity for storage of photographs?

- a) $25^{\circ}\text{C}\pm 2^{\circ}\text{C}$ and 60%RH
- b) $18^{\circ}\text{C}\pm 2^{\circ}\text{C}$ and 30–50%RH
- c) $15^{\circ}\text{C}\pm 4^{\circ}\text{C}$ and 10–20%RH
- d) $20^{\circ}\text{C}\pm 2^{\circ}\text{C}$ and 50%RH

Question 6.

If you have a photographic collection which has been kept in an extreme environment and is in good condition, you should:

- a) take every possible step to change the storage environment so that it meets the recommended ideal conditions;
- b) take steps to improve storage methods and materials but do not alter the environment to meet the recommended ideal conditions;
- c) install air conditioning.

Question 7.

Of the following materials, which are good for storing photographs and which are bad for photographs?

butchers' paper, metal furniture with baker enamel finish, PVC, coated paper, polyester, photographic storage paper, museum mount board, furniture made from uncured wood, black papers containing sulphur, coloured papers, polypropylene, newsprint, photographic-quality wood pulp papers?

Question 8.

Providing layers of storage with individually wrapped photographs placed inside boxes, and in some cases these boxes placed in other boxes:

- a) gives maximum protection from fluctuations and extremes of relative humidity;
- b) is wasteful of materials;
- c) is a good way to fill in time but doesn't do much for the collection;

- d) protects photographs from dust, pollutants, insects and the damaging effects of light.

Question 9.

What function does an acid-free window mount/mat have in a conservation framing system for photographs?

- a) The mount/mat provides a space between the glazing and the image.
- b) The border around the photograph can enhance the appearance of the photograph.
- c) The mount helps to buffer the photograph from changes in relative humidity.
- d) All of the above.

Question 10.

The best kind of light for the display of photographs is:

- a) tungsten incandescent bulbs;
- b) daylight;
- c) low wattage fluorescent tubes;
- d) spotlights for individual images.

Answers to self-evaluation quiz

Question 1.

Answer: Answers could include:

Physical

- dog-eared corners
- insect attack
- abrasion and scratching
- tears and cuts
- creases
- peeling emulsion
- indentations from labelling

Chemical

- fading of the image
- yellowing of B&W images
- colour change of colour prints
- staining
- fading of colour prints
- stains from repair tapes
- silver mirroring (silvering out)

Question 2.

Answer: e): all of the above. Photographs are very susceptible to damage; but if you must handle them they should be supported and you should not handle them directly—wear gloves. Hands should be clean to minimise the risk of oils and dirt being transferred to the photographs.

Question 3.

Answer: b). This is the best way to label photographs. a), c) and d) are wrong. Inks can spread and cause staining; pressure can crack the emulsion and paper clips can damage photographs.

Question 4.

Answer: a) and c). Some aspects of conservation of photographs are complex and you should protect your damaged photograph and seek the advice of a conservator. Never use sticky tapes and rubber cement on photographs.

Question 5.

Answer: b). These are the ideal conditions but they cannot always be achieved.

Question 6.

Answer: b). a) and c) are wrong. If the collection is stable, don't try to alter the storage environment so that it meets the recommended ideal conditions. This could cause more harm than good. The emphasis should be on long-term stability.

Question 7.

Answer:

GOOD	BAD
photographic-quality rag and wood pulp papers	poor-quality papers such as newsprint or butchers paper
plastics such as archival-quality polyester and polypropylene	black papers and boards — these often contain sulphur
photographic storage paper	coloured papers and coated papers
photographic, conservation or museum quality mount board	polyvinyl chloride — PVC — a common plastic
metal furniture with baked enamel finish	furniture made from uncured wood or recently painted furniture

Question 8.

Answer: a) and d). Providing layers of storage is very protective and wastes neither time nor materials.

Question 9.

Answer: d).

Question 10.

Answer: a). Tungsten incandescent bulbs give out very little UV radiation and are not as hot or as intense as spotlights.

PAINTINGS

Objectives	page 111
Introduction	page 111
Structure of paintings	page 111
What are the most common types and causes of damage?	page 114
The do's and don'ts of handling paintings	page 115
Framing paintings	page 118
Hanging paintings securely	page 120
Ideal conditions for the storage and display of paintings	page 121
General storage and display guidelines	page 122
Summary of conditions for the storage and display	page 124
Paintings in Australia's climatic zones	page 124
MORE ABOUT PAINTINGS	
Keying out	page 126
What can go wrong with a stretcher and what you can do	page 126
Handling straps	page 126
Labels and inscriptions	page 126
For further reading	page 126
Self-evaluation quiz	page 127
Answers to self-evaluation quiz	page 129

Objectives

At the end of this chapter you should:

- be familiar with the structure and components of various types of paintings;
- understand possible sources of damage for paintings; and
- know how to frame and hang a painting to ensure proper protection from damage.

Introduction

Early frames were simple affairs. They were usually made from single pieces of wood which were generally either gilded or left plain. They were originally used to protect the fragile edges of panel altarpieces. Then, as paintings became more secular, frames became more decorative and were designed to complement the architecture surrounding them.

So we can see that the frame on a painting serves two purposes:

- it has an aesthetic function—it enhances elements of the painting and unifies the painting with its environment; and
- it also serves as a protective device, providing a physical barrier between the environment and the artwork.

Additional protective components can be added to the frame to:

- protect the back and front of the artwork from knocks and abrasions;
- minimise the effects of vibration and movement;
- enable the work to be hung securely;
- facilitate handling; and
- protect the work from dust and pollution.

Many paintings, however, do not have frames, or they have flimsy and inadequate original frames. Such works are more difficult to protect; but if you

keep the basic principles in mind, you can provide protection for all paintings.

It is important to note that not all frames are protective. While a good-quality, well-constructed frame will provide protection for a painting, a poorly made frame, or one which is not properly fitted to the work, can cause damage.

This section discusses good protective framing practice; it looks at the types of framing systems which are relevant for each type of painting structure and gives general information to help you prolong the lives of the paintings in your care.

Structure of paintings

In order to discuss the possible damage to paintings and to take steps to reduce that damage, it is important to know something of the structure of paintings and the range of materials which can be used to produce them.

Paintings consist at the very least of two layers:

- the support layer on which the image layer rests—this can be canvas, wooden panelling, or Masonite; and
- the image layer—oil paint, acrylic paint or paint in combination with other materials.

If the support and the image layer are not securely bonded, then any movement in the support will damage the paint layer.

Most paintings are more complex than this and have many more parts in their structure. A traditional painting on canvas will usually have:

- a sized support—in many cases canvas sized with skin glue;
- a priming or ground layer;
- the paint or image layer;
- a varnish layer; and
- an auxiliary support which provides physical support for the support layer.

Supports

The term 'support' refers to the layer which carries or supports the paint or image layer.

Paintings can be produced on any type of support.

Traditionally, most supports have been made from linen canvas or wooden panels.



This painting of the Destitute Asylum in Adelaide has been removed from its stretcher for treatment. The canvas support can be clearly seen around the edges of the image.

Photograph courtesy Artlab Australia, reproduced with permission of the Historic Trust of South Australia



This icon is painted on a wooden panel.

Photograph courtesy Artlab Australia, reproduced with permission of Mr Kostya Prosylys

In the 20th century, linen canvas has often been replaced by cotton duck, and wooden panels with compressed particle board such as Masonite.

Artists are creative beings and there are a wide range of materials which have been used in the name of art! They include:

- rigid wooden supports such as particle board products like chipboard or Masonite or the traditional wooden panels;
- rigid supports made from a range of other materials such as glass or metal;
- lightweight cottons or Nylon loosely stretched, which some artists use to give a feeling of fluidity;

- paper glued onto canvas;
- canvas.

The priming and ground layers

Priming and ground layers are used to:

- provide a good physical support for the paint layer; and
- provide a surface to mask the texture of the support. If there are no priming and ground layers, it may be possible to see the texture of the support through the paint.

A good ground layer physically *keys in* the paint layer as it is slightly porous.

The ground layer, however, should not be very absorbent. It must be slightly resistant to the paint, otherwise brushstrokes will not be clear and will sink into the ground.

The support is sized, usually with rabbit-skin glue; and then the ground layers are applied.

Works on canvas usually have two ground layers, although having one or three is not uncommon.

If the ground layers are not well bonded to the support, then movement of the support may lead to a delamination or cracking of the ground.

In addition, if the ground layers are not properly prepared or do not provide a secure base for the paint layer—they may not be porous enough to hold the paint for example—then problems with the paint layer will occur.

A traditional ground was usually made from lead white or a chalk gesso. Acrylic grounds are now common. While grounds are generally white, some artists, John Constable for instance, favoured coloured grounds.

The layers of size and ground can be very reactive; and if they are wet they will cause severe damage to the paint layers.

The paint layer

The paint layer or image layer can be made up of paint and a number of other materials, including paper or found objects in collage.

Oil paint is the traditional paint medium, however, in more recent times synthetic materials such as acrylics and alkaloid resins are common.

Oil paint dries by evaporation, and then by a chemical crosslinking process. This means that it becomes less flexible as it ages.

The varnish layer

Varnishes are applied on top of the paint layer. They are applied as liquids and dried to produce clear, tough films.

They protect the paint layer—to a degree depending on their composition—from physical damage and chemical attack.

Varnishes also have an aesthetic function: they smooth out the unevenness of the paint surface so preventing light being scattered when it is reflected. This gives the colours in the work a more saturated appearance—the colours appear darker and have greater depth.

It is important to note that further paint layers and transparent coloured layers known as glazes may be applied over the varnish layer. This technique produces an illusion of depth.

A range of materials have been used as varnishes. Among the most stable are:

- Dammar dissolved in turpentine—this is an example of a traditional varnish made from natural resins dissolved in solvents; and
- acrylic resins dissolved in petroleum spirit.

Auxiliary supports

Traditionally, paintings on canvas have been attached to auxiliary supports—usually a stretcher or a strainer—using staples or tacks.

The purpose of the auxiliary support is to secure the canvas and keep it taut. It is important to keep the support as taut as possible—loose supports will undergo far greater dimensional change in response to fluctuations and so are much more vulnerable to damage.

A stretcher differs from a strainer in that the corners of a stretcher can be keyed out, thereby tightening the canvas.

The corners of the stretcher are adjustable, enabling the dimensions of the stretcher to be enlarged to tighten the canvas. This is done by pushing the keys further into the keyholes, and expanding the corners.



A stretcher—note the keys in the corners.

Photograph courtesy of Artlab Australia

CAUTION:

Because inappropriate tightening of the canvas can cause damage, you need to know what you are doing, or be shown by a conservator, before you commence keying out a work.

A strainer is a wooden frame which does not have adjustable corners. Therefore if the canvas becomes loose over time, it cannot be made taut again without being re-stretched—this is a job for a conservator.



A strainer.

Photograph courtesy of Artlab Australia

Examples of other auxiliary supports include:

- cradles placed on the backs of panel paintings; and
- wooden frames used to secure Masonite supports.

What are the most common types and causes of damage?

As with most cultural material, the deterioration of paintings is caused by physical damage and chemical activity—usually in combination.

Physical damage is very obvious and includes:

Tears and breaks. For example, many canvas paintings are damaged when people are working near the paintings and accidentally put the handle of a broom, a ladder etc. through the canvas. This is not uncommon.



This pre-treatment photograph shows severe tears in the canvas support of a painting.

Photograph courtesy Artlab Australia

Cracking of varnish and paint layers because of movement of the support, due to:

- vibration during handling and travel;
- impact when a painting is dropped, knocked or falls off a wall; and
- fluctuations in relative humidity. Both canvas and wood take up and release moisture as the relative humidity fluctuates. This produces dimensional changes which can lead to cracking of the paint and varnish.

Separation of the different layers of the painting structure. This can be caused by fluctuations in relative humidity and/or to impact.

Softening of the varnish layer in high temperatures. The varnish can become sticky and any dust or dirt on the surface may become permanently attached to the painting.

Warping of the stretcher due to extremes and fluctuations in relative humidity, and lack of proper support in storage or display.

Insect attack, for example, wooden stretchers can be attacked by borers and canvas and cardboard supports can be attacked by silverfish.



This stretcher had been exposed to quite extreme fluctuations in relative humidity causing it to warp severely. In time, this resulted in the structural breakdown of the stretcher with obvious damage to the canvas support.

Photograph courtesy Artlab Australia

Dust and dirt can distort paintings if allowed to collect between the lower stretcher bar and the canvas. This can lead to distortion of the paint layer. Dust will also take up and hold moisture, thus creating a localised area of high humidity—this can lead to localised dimensional change and overall distortion.

Chemical deterioration can be very damaging and will often mar the appearance of paintings. Chemical damage to paintings includes:

Colour change and fading of pigments when exposed to light and UV radiation. Oil paintings are often considered to be quite stable in light, but some pigments and glazes are particularly susceptible to light damage.

Discolouration of the varnish. This may be due to exposure to light and UV radiation and/or because of the natural ageing of the particular varnish.



This photograph taken during treatment shows clearly the degree to which varnish can discolour and alter the appearance of a painting.

Photograph courtesy Artlab Australia, reproduced with permission of Mr Paul Fitzgerald

Deterioration of some components of the painting where poor-quality materials have been used or where the painting has not been properly structured.

Reactions between incompatible components of the painting. This is more likely to occur when the painting is a complex collage made up of a combination of paint and a number of other materials.

Cracking or movement of paint layers due to the unstable nature of one or more of the components of the painting. Bituminous additives in paint are an example of one of these unstable materials.

Mould attack. All components of paintings are susceptible to mould in high-humidity conditions.



The appearance of this painting was marred by patches of mould growth.

Photograph courtesy Artlab Australia, reproduced with permission of B. W. Johns

Changes due to the action of atmospheric pollutants, for example:

- colour change in pigments;
- breaking down of structural components leading to loss of strength; and
- alterations in solubility characteristics of paint films and varnishes.

The do's and don'ts of handling paintings

Because paintings are such complex structures, it is important to understand correct handling procedures. Remember, a paint surface may receive a knock and appear to be unharmed. But over time movement in the canvas will cause this weakened area to crack. It can take a decade or longer for a crack to appear after a knock.

Handling stretched paintings and framed works

It is very difficult to properly support and protect paintings if you carry more than one at a time. It is important that you always carry only one painting at a time.

Before moving any painting:

Check that there is no flaking paint and that the work is secure in its frame.

Check that there are no loose pieces on the frame. If there are, consult a conservator.

Make sure you know where you are going with the work, and you have checked your path to make sure it is clear and all doors are open, or that there are people available to assist.

If there is flaking paint on the painting, leave it face-up and consult a conservator. If you have to move it, carry it flat and face-up, so that you don't lose any paint while you are moving.

Do not touch the canvas or the paint surface directly.

Wearing white, cotton gloves while handling paintings and frames is advisable, particularly

when handling gilded frames. Gilt surfaces can be permanently marked by perspiration and oils from your skin.

If your canvas painting does not have a backboard, check that the stretcher wedges are secured. They can do a lot of damage if they fall between the canvas and the stretcher.

Always hold paintings at points where the frame is strong. Ornate frames are especially vulnerable to damage. Never grip them by any of the ornate areas of the frame, because they may not be very strong and could break.

Never carry a painting by the top of its frame or stretcher. Carry it with one hand beneath and one hand at the side; or if it is small, one hand on each side. Carrying frames from the top member is dangerous and can cause the mitres to become loose and decorative elements to dislodge.

If the work is unframed, it is better to move it using handling straps or a travelling frame. Both of these allow you to carry paintings without the need for you to touch the paint surface. If neither of these are available, then carry unframed, stretched paintings on the outer edges without touching either the front or back of the canvas. Don't allow your fingers to touch the paint surface.



Handling straps attached to the back of a backing board.

Photograph courtesy Artlab Australia

Don't put your fingers around the stretcher bars, or between the stretcher and the canvas, because you could cause the canvas to bulge and the paint to crack and flake in that area.

Remember to carry wrapped paintings with extra care, because you cannot see what you are touching.

Before putting a painting down on the floor, ensure that there are padded, wooden blocks or foam blocks in place where you wish to place it. These blocks provide a softer surface than the floor and keep paintings up off ground-level.

When you put the painting down, do not set it down on one corner: always set it down along one complete edge.

A large painting must be moved by two people regardless of the weight involved. Never attempt to move a large painting alone. When two people are working together, make sure you both agree on the way the painting is to be moved.

If you are moving paintings on a trolley, it is wise to have two people to accompany the loaded trolley. With two people, you have one to hold the paintings in place while the other can open doors, etc. If one person tries to do everything at once, accidents are likely to happen.

Trolleys should be padded to prevent damage to frames.

If any damage should occur during the move, carefully collect and save any pieces, no matter how small—even tiny paint flakes—and document the damage.

If you are hanging a painting, check that the hanging devices and the wall on which the painting is to be hung are secure. Paintings can be very badly damaged if they fall off the wall.

When you are framing or deframing a painting, make sure that you have a clean, padded surface on which to place both the frame and the painting.

Moving framed paintings with glazing

'Glazing' usually refers to the glass or Perspex sometimes used in framing systems for paintings.

Glazed artworks should be carried with care:

- acrylic glazing such as Perspex is easily scratched; and
- glass can break if dropped or knocked.

If you are transporting paintings glazed with glass, tape the front of the glass with masking tape. This will hold the pieces of the glass together, should it break, and lessen the risk of damage to the work.

The tape should be on the glass only, and should not extend onto the frame because it can remove paint or other finishes when it is removed.

For small frames, one strip of tape vertically in the centre of the glass, one horizontally and one strip of tape on each diagonal will be sufficient. Larger frames will need more.

Fold the tape back on itself at one end of each strip, to provide yourself with a grip for easier removal of the tape.

Remove the tape as soon as possible after the move. Pull the tape off at a very low angle, so that you don't make the glass flex too much. This could cause it to break. Remember, pull gently.

It is better not to tape Perspex or Plexiglas as:

- the tape can be very difficult to remove;
- it can leave adhesive residues which cannot be cleaned away; and
- there is, after all, really no need to tape Perspex or Plexiglas because they won't break and shatter like glass.

Handling unstretched paintings

Not all paintings are stretched and framed. Many paintings are now sold and kept, unstretched. Because the canvas is not kept taut, these paintings are particularly vulnerable to damage caused by movement of the support.

Unstretched paintings can be quite difficult to handle. If they are allowed to flop or move too much, the paint can begin to come away from the surface of the canvas; so it is very important that unstretched paintings are well supported.

If the paintings are small enough to be moved flat, put a rigid support under them so that they can be handled easily without flopping and distorting. A sheet of Foam Cor or a strong mount board is suitable.

Larger unstretched paintings may need to be rolled to be carried, and transported.

If you are going to roll a painting it is very important that paintings are rolled the right way—painted side out—and that they are properly interleaved and the roller properly padded. If the paint layer is on the inside when the painting is rolled, the paint will become compressed and will develop creases, which will remain in the painting after it has been unrolled.

The roller should be as large as possible in diameter—at least 200mm. For example, a very large acrylic painting which travelled to the USA in the South Australian Museum's Dreamings exhibition was rolled on a roller more than one metre in diameter. The larger the painting, the larger the diameter of the roller should be.

Rollers should be covered with a layer of padding—either a polyethylene foam such as Plastazote, or Dacron wadding covered with clean white cotton fabric—to compensate for any irregularities in the painting's thickness.

It is best to roll the painting with an interleaving layer of Tyvek to prevent any transfer of pigment. The Tyvek should be larger in length and width than the painting.

The rolled and wrapped painting should be tied firmly, but not tightly, with cotton tape in several places along the roll.

Rollers can be specially made of lightweight materials, such as:

- Ribloc. Ask the manufacturer to make the roller with the ribs on the inside, if possible; and
- PVC pipe. A 300mm diameter pipe is a good size for most works.

If you have to roll more than one painting on a roller, the paintings should be laid out flat and interleaved with Protecta Foam. Once this is done, the paintings should be rolled onto the roller all at the same time. Remember, all the paintings should be paint-side out.

Framing paintings

Framing for protection

As already noted, frames are important protective devices. Good framing is as much common sense as anything else but certain principles should be kept in mind.

The painting needs to be protected at the front and back if possible, from damage caused by:

- knocks and abrasions;
- dust and pollution;
- environmental fluctuations; and
- biological pests.

For this reason you should provide a backing board for your paintings, and consider glazing works.

The painting needs to be protected from vibration as much as possible. For this reason the frame needs to hold the work firmly but allow some cushioning, so that if the painting is knocked the frame will take the force of the impact. The painting will need to be keyed out if the canvas becomes loose. Make sure that the painting does not fit too tightly in the frame.

Other considerations—*aesthetics and history*

When making any decisions about whether to retain, replace or repair an original frame, it is important to understand the history of the painting and its frame.

Many artists consider the frame to be an important part of the presentation of their work. For some it is even an intrinsic element. Keep in mind that frame styles reflect the period of the artwork and/or the design of the individual artist.

It is important to note that in some instances the frame will have been conceived as part of the original aesthetic of the work. For example:

- the 1889 9' x 5' exhibition is perhaps the most well known Australian example of artists making very specific decisions about their frames;

- many contemporary artists have very definite ideas on the framing of their work; and
- Fiona MacDonald is an example of a contemporary Australian artist who uses the frame as part of the aesthetic of her work. To replace the frame would be akin to replacing part of the work.

Many frames are important aesthetic statements in their own right and may be valuable historic items. For example, framemakers Robin Hood and Isaac Whitehead were important Australian framemakers. An original frame by these framemakers is likely to be worth a substantial amount of money, certainly in the tens of thousands for a large, ornate frame in good original condition.

In other instances the artist may have no interest in the frame at all. Works may be sold unframed or the artist may simply have a trade order with a framer.

Decisions about framing and reframing, therefore, need to be made carefully and with a proper understanding of all the issues.

Backing boards

Backing boards protect the painting by providing a physical barrier between the back of the painting and the external environment.

It is obvious that one of the most important things you can do to protect a painting is to provide it with a snugly fitting backing board. A backing board will help to protect against:

- knocks;
- changes in temperature and humidity;
- the effects of atmospheric pollution;
- lodgement and build-up of dust;
- insect and mould attack.

Various types of material can be used for backing boards. It is important to choose a material which is lightweight, but still strong enough to take knocks and to provide a physical barrier. Two materials which have been used widely in recent times are:

- Foam Cor—a composite consisting of outer layers of paper and an inner layer of polystyrene; and
- Corflute—a synthetic corrugate.

pH-buffered, corrugated archival cardboard and other stable materials can also be used. The abovementioned materials are considered to be more chemically stable than timber or Masonite.

If you retain a timber or Masonite backing, introduce a barrier between it and the painting. The barrier could be acid-free paper or board.

Sometimes a work will have an original backing board with inscriptions and labels. If this is the case you will probably want to retain this information. If the labels are in poor condition, you should consult a conservator regarding their preservation. All labels and inscriptions provide potentially valuable information about the work. It is important to transcribe this information into any records you keep about the painting, including condition reports.

Sometimes a backing board may hide information on the canvas.

In some instances a conservator will transcribe this information onto the backing board, noting that the original exists on the canvas.

If the back of the work has a large amount of information or you want the information to be visible, a sheet of Perspex can be used as the backing board. In this way, the work is protected while still allowing the back of the work to be viewed.



Back of framed painting showing Corflute backing board screwed to the frame.

Photograph courtesy Artlab Australia

Backing boards are screwed into the back of the frame and should fit well enough to make a dust seal. They provide more protection from impact if they are attached to the frame—because the frame, rather than the painting, will absorb most of the shock.

It is important to note that backing boards should not be attached to the stretcher or strainer, because this weakens the structure and may necessitate putting holes in the canvas, which could lead to tearing.

Glazing

Glazing is a generic term and usually refers to glass or Perspex.

When glazing, you should ensure that:

- there is sufficient space between the glass or Perspex and the surface of the work, so that the paint surface will not touch the glazing. Slips and spacers should be used to provide this space. Slips are visible and can be a decorative element in the frame. Spacers are not seen;
- Perspex is not used where there is any danger of the paint or image layers being affected by static electricity, for example, where there is flaking paint or where there is mixed medium such as in collage; and
- you do not use glazing when framing works which have been recently varnished, because the varnish will not be able to dry properly and may develop a white bloom.

There are a number of different types of glass on the market, including very expensive, water-clear bullet-proof glass. If you want to use this glass, you should check with your State art gallery to see if they have a local supplier, as this glass is not readily available.

Putting the painting in the frame

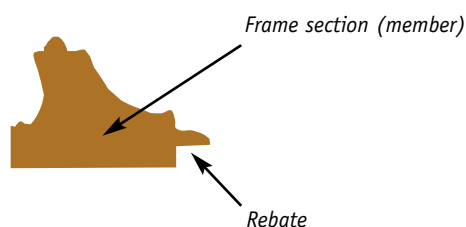

The following diagram shows how a stretched canvas painting should be fitted in a frame to provide a protected environment for the painting.

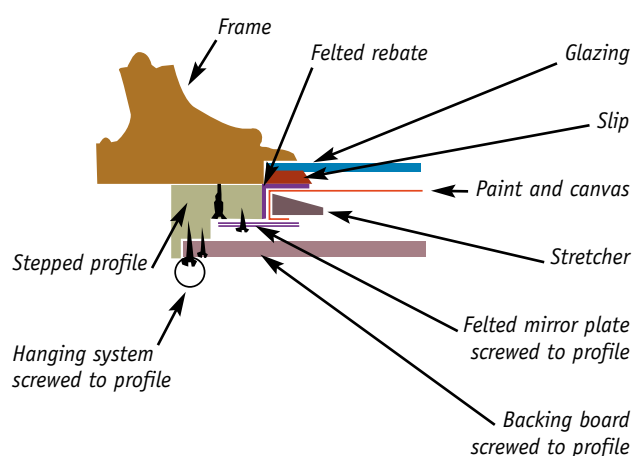

The back of the frame is built up with a profile section screwed to the frame. This increases the depth of the rebate, and provides the recessed space for the mirror clips and backing board.

The slip is necessary to ensure that the paint surface does not contact the glass.

The slip, rebate and mirror plates—that is all surfaces contacting the painting—need to be felted with either a polyester felt or an inert cushioning material such as Cellair.

If the painting fits loosely in the frame, spacers should be used to bulk out the rebate. Rag board, pH-buffered cardboard, balsa wood, cork and Foam Cor are suitable materials. These spacers should be glued to the rebate to prevent them slipping out of place and so to reduce the risk of damage to the painting.

Felted mirror plates are used to hold the painting in the frame. These can be bent slightly to hold the painting and are screwed into the profile.

Panel paintings should be held in place by two mirror plates placed at either side of the painting in line with the grain of the wood. This means that, if necessary, there is some freedom of movement of the wood. Remember that if a panel is unable to move it will crack.

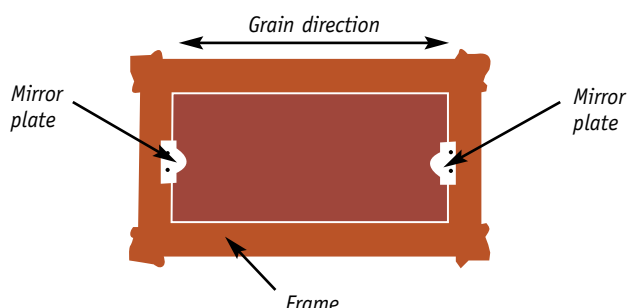

CAUTION:

You will find that many works are held in the frame with nails. Hammering nails into place causes severe vibration which can lead to damage.

Nails can also be difficult to remove without damaging the tacking edge and the stretcher. If the nails pass through the stretcher, then the painting cannot be keyed out. When reframing these paintings, remove the nails and do not replace them. Instead, use metal plates or mirror plates which can be screwed into place.

Hanging paintings securely

For safe hanging, paintings need to be secure in their frames and each frame needs to be securely hung from **two** points in the wall, with a hanging device attached to **two** points on the frame.

Paintings of different size and weight may require different hanging systems, but if you think sensibly about the problems that may arise when you are hanging a particular work, most problems can be averted.

There are two main principles to keep in mind when hanging a painting:

- the work should be properly supported for its weight; and
- there should be no stresses on any part of the hanging system or the painting.

Some basic principles to keep in mind are:

Use materials which will not rust. For example, you should use nickel-plated screws, brass or nickel-plated screw eyes or D-rings, and non-rusting multi-strand wire if you are using wire. If you use materials which rust, they will lose strength when they rust and your paintings will be at risk.

Ensure that the wall into which the hanging system is secured is stable and structurally sound. If possible hang works from a well secured picture rail. If this is not available, make sure that you attach the plugs or secure hooks with toggle bolts into the studs in the wall structure.

Ensure that stresses are evenly distributed across the work. If the work is large, use a shelf to take the weight.

Do not hang the painting from one point, because this will create stress across the back of the frame, weakening corners and opening mitres. On an ornate frame this may result in loss of decoration.

For a light- to medium-sized framed painting:

- the work should be hung from two separate points on the wall, with the hanging device attached to two points on the back of the frame;
- the hanging devices should be strong enough to take the weight of the work without becoming stressed or warped; and
- if you are using hanging wire, ensure that it is not crimped as this will be a weak point.

For hanging a heavy work:

- use a shelf to evenly distribute the weight along the bottom of the work, and use the hanging devices to secure the work against the wall; and
- if necessary provide four or more hanging devices, such as mirror plates screwed to the frame and then into secure sections of the wall.

Hanging devices

Hanging devices need to be strong and rust-proof. D-rings are preferable to screw eyes because they are less likely to snap and are not weakened by the screwing process.



D-rings.

Photograph courtesy of Artlab Australia

Mirror plates are another secure method of hanging paintings.

OZ Clips are useful for large works with thin frames, particularly those which are kept in travelling frames.



Oz clips.

Photograph courtesy of Artlab Australia

There is also a range of security screws which can be used when a painting requires protection against theft.

Ideal conditions for the storage and display of paintings

As we have seen, paintings are made up of a number of different materials. Each of these materials has its own particular sensitivity to the surrounding environmental conditions. However, unless you are able to identify the exact materials you will not know their exact sensitivity. To assist museums, galleries and libraries in looking after

their collections, guidelines for the ideal storage and display environments have been developed.

Ideally, paintings should be stored in an environment where:

Temperature is constant and moderate—in the range 18–20°C.

If temperatures are generally outside this range in your area, try to ensure that fluctuations are not rapid and are kept to a minimum.

Relative humidity is in the range 45–55%.

This is important for paintings, because most of their components are moisture-sensitive and extremes of relative humidity can lead to physical damage.

Fluctuations in relative humidity should be kept to a minimum and should not be rapid. Fluctuations in relative humidity can lead to severe distortion and to separation of the paint from underlying layers of the painting structure.

Light is kept to the minimum necessary for the activity.

If possible, store paintings in the dark. If light is not required for viewing while the works are being stored, then there is no need for them to be illuminated. This will reduce the risk of fading and discolouration of particularly sensitive components of the painting.

For display it is necessary to have light; but the brightness of the light should be less than 250 lux.

The UV content of the light should be no greater than 75µw/lm and preferably below 30µw/lm.

Steps are taken to protect paintings from dust and pollutants.

For more information

For more information about temperature, relative humidity, light and UV, please see *Damage and Decay*.

General storage and display guidelines

Careful consideration should be given to the storage site and the storage system. In situations where you are able to achieve the ideal conditions, a good storage system in an appropriate storage site will give added protection to your collection. If the available facilities or the local climate make it difficult for you to achieve the ideal conditions, the selection of the storage site and the maintenance of a good storage system will become even more critical in preventing damage to the collections.

Wherever possible the storage and display sites should be in a central area of the building, where they are buffered from the extremes of climatic fluctuations which can be experienced near external walls or in basements and attics. Basements should also be avoided because of the risk of flooding.

The storage site should not contain any water, drain or steam pipes, particularly at ceiling level. If these pipes were to leak, extensive damage could result.

The storage and display sites should be reasonably well ventilated. This will help reduce the risk of insect and mould infestation.

Inspect and clean storage and display areas regularly. Thorough and regular cleaning and vigilance will also greatly assist in the control of insects and mould.

Do not store paintings in sheds or directly on the floor.

Cover stored paintings with a Tyvek cover. These are easy to make for individual works, using a domestic sewing machine. They will protect the paintings and their frames from dust and insects. These covers will also help to protect the works from fluctuations in environmental conditions.

Always give paintings adequate support and try to reduce the physical stresses which can cause damage.

If you have a number of paintings which are to be stored for considerable periods, consider designing a specific storage area so the paintings can be

hung securely for storage. A heavy-gauge wire grid can be used for this purpose. If considering building such a system, consult a conservator for further details.

If paintings are to be stored against walls, ensure that they are placed on padded blocks to take them off the floor level; and ensure that they are not near heavy traffic areas, because they could be damaged as people walk past them or if people drop things on them.

Design your display lighting so that the heat produced by the lights does not affect the paintings.

Heat associated with light can cause localised and differential environmental changes, and subsequent dimensional changes across the painting.

Always avoid direct sunlight on your paintings.

Storing unstretched paintings

Ideally, unstretched paintings should be stored flat. But many larger paintings are too large for flat storage in standard storage furniture. For the full protection of these larger paintings, rolled storage is recommended.

It is important to note that for the flat storage of unstretched paintings, the paintings should be kept on wide, flat shelves or in large flat drawers such as plan chest drawers.

The shelves or drawers should be larger than the paintings. This prevents distortion of the edges of the canvas.

Paintings can be stacked one on top of another, but paintings can be quite heavy and the ones on the bottom have to carry the weight of those on top. So be sure to limit the number of paintings per stack.

Stacked paintings should be interleaved with thin Protecta Foam sandwiched between acid-free tissue.

If possible place the paintings in a large storage box, 100–150mm deep.

When rolling paintings for storage, it is important to note that:

- paintings must be rolled painted side out, otherwise permanent damage which mars the appearance of the work can result;
- paintings should be properly interleaved and the roller properly padded;
- the roller should be as large as possible in diameter—at least 200mm.

Rollers can be specially made of lightweight materials, such as:

- Ribloc, with the ribs on the inside;
- PVC pipe. A 300mm diameter pipe is a good size for most works;
- if you are using a cardboard tube to roll a painting, pad it out to as large a diameter as possible.

Rollers should be covered with a layer of padding—either polyethylene foam such as Plastazote or Dacron wadding covered with clean, white cotton fabric—to compensate for any irregularities in the painting's thickness.

It is best to roll the painting with an interleaving layer of Tyvek, to prevent any transfer of pigment. The Tyvek should be larger in length and width than the painting. When rolled, the painting should be tied firmly, but not tightly, with cotton tape in several places along the roll.

If more than one painting is to be rolled on a roller, the paintings should be laid out flat and interleaved with Protecta Foam, as for flat storage. Once this is done, the paintings should be rolled onto the roller, all at the same time. Remember, all the paintings should be paint side out.

Summary of conditions for storage and display

	Storage	Display
Temperature	18°C–22°C	18°C–22°C
Relative Humidity	45–55%RH	45–55%RH
Brightness of the Light	Dark storage preferred, but if light is present it should not be higher than 250 lux.	Should not be higher than 250 lux.
UV Content of Light	Dark storage is preferred but if light is present, UV content should be and no greater than 75 $\mu\text{W}/\text{lm}$ and preferably below 30 $\mu\text{W}/\text{lm}$.	No greater than 75 $\mu\text{W}/\text{lm}$, preferably below 30 $\mu\text{W}/\text{lm}$.

Paintings in Australia's climatic zones

The climatic zones outlined below are broad categories. Conditions may vary within these categories, depending on the state of repair of your building and whether the building is air conditioned or not.

Remember that the variations in environmental condition across Australia are extreme. Therefore, you should be careful if you are transporting paintings from one climatic zone to another—for example, transporting works from a warm moist tropical environment to an air-conditioned gallery. If works are travelling, ensure there is enough time to acclimatise them on their arrival and return.

Arid

This climate is generally very dry, however in arid areas it is often very hot during the day and very cold at night. This wide fluctuation in temperature is matched by wide fluctuations in relative humidity, for example from 75%–20% in a day.

When caring for paintings in an arid climate it is important to note:

- Many of the materials that make up paintings will tend to give out the water they contain—this can lead to components of the paintings becoming dry and brittle;
- The composite nature of paintings means that they are particularly susceptible to damage from fluctuations in temperature and relative humidity. As the different materials release moisture at different rates, warping, dimensional change and delamination of layers of the painting structure can result;
- Remember that even arid areas can have periods of higher relative humidity—even though the periods may only be very short. High humidities will cause swelling of some materials, and will increase the likelihood of insect and mould attack;
- Dust can be a major problem for paintings in an arid climate. It is important that paintings are glazed if dust is a problem; and
- For particularly sensitive, reactive works you may consider placing RH buffered fabric or silica gel cells into the framing structure. You will need to discuss this with a conservator.

Note: If your collections of paintings have been kept in an arid environment for a considerable period and they are stable—**do not** try to alter the environment to meet the recommended ideal conditions. This could do more harm than good. The emphasis should be on long term stability.

Temperature

A temperature climate is considered a moderate climate, however, temperate climates tend to have a greater range of temperatures than tropical climates and may include extreme climatic variations.

- If you redecorating or designing storage and display areas, consider using materials that will help to buffer these areas against rapid fluctuations and extremes of relative humidity and temperature. This will help to reduce the risk of damage due to the fluctuations and extremes that occur in temperate environments.
- Remember that many of Australia's main cities and major regional centres are in temperate regions. These areas tend to be heavily polluted and this should be taken into account.
- Salt laden winds and dust can be problems in many urban and rural areas in temperate zones.

Note: If your collections of paintings have been kept in a temperate environment for a considerable period and they are stable—**do not** try to alter the environment to meet the recommended ideal conditions. This could do more harm than good. The emphasis should be on long term stability.

Tropical

These climates are characterised by heavy rainfall, high humidity and high temperatures.

When caring for paintings in tropical climates it is important to note that:

- insects and moulds thrive and reproduce readily;
- chemical deterioration reactions generally proceed faster at higher temperatures;
- materials that have been in a tropical environment for some time will have a high moisture content. If they are suddenly moved into a drier environment they are likely to suffer shrinkage and warping of the support and stretcher;
- many of the materials which make up paintings are very reactive to changes in relative humidity. For example the animal skin glue used as the size will soften; a wooden stretcher may warp, etc.; and
- composite works such as collage will be particularly vulnerable.

Controlling moisture is important in a tropical environment.

Condensation may be a problem for glazed works and you may need to consider providing air holes in the backing board to allow adequate air flow. Cover these air holes with gauze to prevent insect entry.

Ensure that your storage and display spaces have good air flow.

For particularly moisture sensitive works you may consider placing RH buffered fabric or silica gel cells within the frame. You will need to discuss this with a conservator.

Note: If your collections of paintings have been kept in a tropical environment for a considerable period and they are stable—**do not** try to alter the environment to meet the recommended ideal conditions. This could do more harm than good. The emphasis should be on long term stability.

MORE ABOUT PAINTINGS

Keying out

There are a number of problems which can arise when a work is keyed out. For this reason you should never attempt to key out a work unless you have been trained to do this properly by a conservator and you are aware of potential problems.

Older canvases can be extremely brittle and may tear at the corners, or elsewhere along the rollover or tacking edge.

Some paintings which have been distorted over a period of time may have a very strong plastic memory in their canvas or paint layers and keying them out may cause severe stress with cracking and even cleavage and flaking in the stressed areas.

You should carefully consider the strength of the adhesion on mixed-media works such as collage, which may delaminate with movement of the canvas.

What can go wrong with a stretcher and what you can do

As the purpose of the stretcher is to ensure that the canvas is kept taut, it is obvious that a stretcher which can no longer be keyed out is not performing its function properly.

One of the most common reasons for a stretcher to fail is that the keys become damaged—with the protruding end breaking off and the remainder of the key becoming lodged in the keyhole. The removal of the remnants of the key is usually a job for a conservator, because it involves separating the two stretcher members.

In some cases, a stretcher will not remain keyed out and keeps pulling back. If the reason for this is not clear—such as material caught in the key holes—you should consult a conservator.

Sometimes stretchers warp and the temptation is to replace them. If, however, the canvas has taken on the plastic memory of the warped stretcher shape, then replacing the warped member with a straight one may cause more problems than it solves. If in doubt, consult a conservator.

Handling straps

When the work has no frame, handling straps made of synthetic webbing can be screwed onto the backs of frames or stretchers. These materials are available at marine or mountaineering suppliers. Handling straps provide added support for carrying when the frame is too weak or insubstantial to be used for carrying, or when there is no frame, or the work is particularly large and additional support is required.

Labels and inscriptions

The types of labels and inscriptions commonly found on backing boards include framemakers' labels, chalk marks from auctioneers' rooms, names and addresses, and other ancillary material. All this material should be noted on the accessioning documentation and the condition report as it can be critical when trying to determine provenance, examine authenticity or simply undertake historical studies.

If you have a problem related to the care, framing or hanging of paintings contact a conservator. Conservators can offer advice and practical solutions.

For further reading

Clifford, T. 1983, The Historical Approach to the Display of Paintings, *Journal of Museum Management and Curatorship*, Vol. 1 (2), Butterworth Scientific Ltd, Guildford, UK, pp 93–106.

Editorial 1987, *Journal of Museum Management and Curatorship, Frames and Framing in Museums*, vol. 4, 1985, pp 115–117; Vol 6, Butterworth Scientific Ltd, Guildford, UK, pp. 227–228.

Hackney, Stephen 1990, 'Framing for Conservation at the Tate Gallery', *The Conservator*, Number 14, The United Kingdom Institute for Conservation, London, pp44–52.

Hasluck, Paul N. 1912, *Mounting and Framing Pictures*, Cassell and Company Ltd, London.

Keck, Caroline K. 1965 reprinted 1980, *A Handbook on the Care of Paintings*, American Association for State and Local History, Nashville.

McTaggart, Peter and Ann 1984, *Practical Gilding*, Mac & Me Ltd, Welwyn, UK.

Payne, John and Chaloupka, Peter, 1986, 'Framing the 9 x 5s', *Bulletin of the Society of the National Gallery of Victoria*, The Society of The National Gallery of Victoria, Melbourne, pp 11–12.

Seager, Christopher; Hillary, Sarah L.; Weik, Sabine 1986, *Art Care. The Care of Art and Museum Collections in New Zealand*, Northern Regional Conservation Service, Auckland City Art Gallery, Auckland, N.Z.

National Gallery of Art 1991, *Art in Transit: Studies in the Transport of Paintings*, National Gallery of Art, Washington, DC.

Self-evaluation quiz

Question 1.

The support layer of a painting is:

- a) the layer put on the back of the frame to support it;
- b) the framework that supports the canvas;
- c) the rigid board used to support unstretched paintings when they are being carried; or
- d) the layer which carries or supports the image or paint layer.

Question 2.

Which of the following statements are true?

- a) Traditionally paintings were produced on stretched canvasses or wooden panels.
- b) There is no difference between a stretcher and a strainer.
- c) The varnish layer serves only to make the painting look glossy.
- d) A stretcher differs from a strainer in that the corners of a stretcher can be keyed out to tighten the canvas.
- e) Paintings can be produced on a range of supports.

Question 3.

Fluctuations in relative humidity can damage paintings by:

- a) producing dimensional changes in the support, which can lead to separation of the image layer from the support;
- b) producing dimensional changes in the support, which can lead to cracking of the paint and varnish layers;
- c) warping the stretcher, which in turn produces distortion of the canvas support;
- d) increasing the risk of mould attack when the relative humidity is high; or
- e) All of the above.

Question 4.

Which of the following statements are false?

When handling paintings you should:

- a) Be sure the painting and frame are secure and safe to move.
- b) Put your hand around the stretcher bar with your fingers between the stretcher and the canvas. This allows you to get a good grip.

- c) Check your route and make sure it is clear. Also make sure all doors are open and that there are people available to assist if you need them.
- d) Carry more than one painting at a time.
- e) Carry wrapped paintings with extra care, because you cannot see what you are touching.

Question 5.

A good protective framing system will:

- a) Protect a painting from knocks, because the frame will take the force of the impact.
- b) Include a backing board, to protect the back of the painting from impact damage and to significantly reduce the risk of insect attack and dust build-up.
- c) Be designed with protection, the history of the painting and aesthetics all taken into account.
- d) Have a slip or a spacer to keep the glazing away from the paint surface.
- e) All of the above.

Question 6.

When putting a painting into its frame, you should:

- a) Use hammer and nails to fix the painting in place as this is difficult for people to undo and will ensure that it won't come loose.
- b) Ensure that all surfaces contacting the painting eg. the slip, the rebate, the fixings etc are cushioned with an inert cushioning material.
- c) Use spacers between the painting and the frame, if the painting fits loosely in the frame.
- d) Build up the back of the frame with a stepped profile section to accommodate the backing board, the painting and the glazing and slip, if the frame includes glazing.

Question 7.

Which of the following statements are true?

- a) Paintings should be hung securely because they can be badly damaged if they fall off the wall.
- b) Paintings should be hung from two points on the wall.
- c) The hanging devices should be strong enough to take the weight of the work without becoming stressed or warped.
- d) The hanging device should be attached to two points on the frame.
- e) If the work is exceptionally heavy, additional support can be given by resting the base of the frame on a shelf.

Question 8.

What are the ideal conditions for storing and displaying paintings?

- a) 18-22°C, 55-70% RH, brightness of the light at 550 lux and the UV content of the light no greater than 75µW/lm and preferably below 30µW/lm.
- b) 20-30°C, 45-55% RH, brightness of the light at no more than 250 lux and the UV content of the light no greater than 200µW/lm and preferably below 100µW/lm.
- c) 18-22°C, 45-55% RH, brightness of the light at no more than 250 lux and the UV content of the light no greater than 75µW/lm and preferably below 30µW/lm.
- d) None of the above.

Question 9.

When storing paintings, you should:

- a) Ensure that they have adequate support.
- b) Place them on padded blocks on the floor, in an area where people are likely to walk past them often so that they can check their condition regularly.

- c) Protect them from dust and fluctuations in relative humidity.
- d) Roll large, unstretched paintings if you do not have storage furniture which can accommodate them flat.

Answers to self-evaluation quiz

Question 1.

Answer: d).

Question 2.

Answer: a), d) and e) are true. b) is false. There is a difference between a stretcher and a strainer. A stretcher can be keyed out to tighten the canvas, whereas a strainer cannot. c) is false. The varnish layer protects the paint layer and gives the paint colours a richer appearance.

Question 3.

Answer: e).

Question 4.

Answer: b) and d) are false.

Question 5.

Answer: e).

Question 6.

Answer: b), c) and d) are correct. a) is incorrect. Nails should not be used to fix paintings into a frame, because hammering them in causes vibration which could lead to considerable damage.

Question 7.

Answer: a), b), c), d) and e) are all true.

Question 8.

Answer: c).

Question 9.

Answer: a), c) and d). b) is not correct. If paintings are to be stored against walls, you should ensure that they are placed on padded blocks to take them off the floor level, and ensure that they are not near heavy traffic areas, because they could be damaged as people walk past them or if people drop things on them.

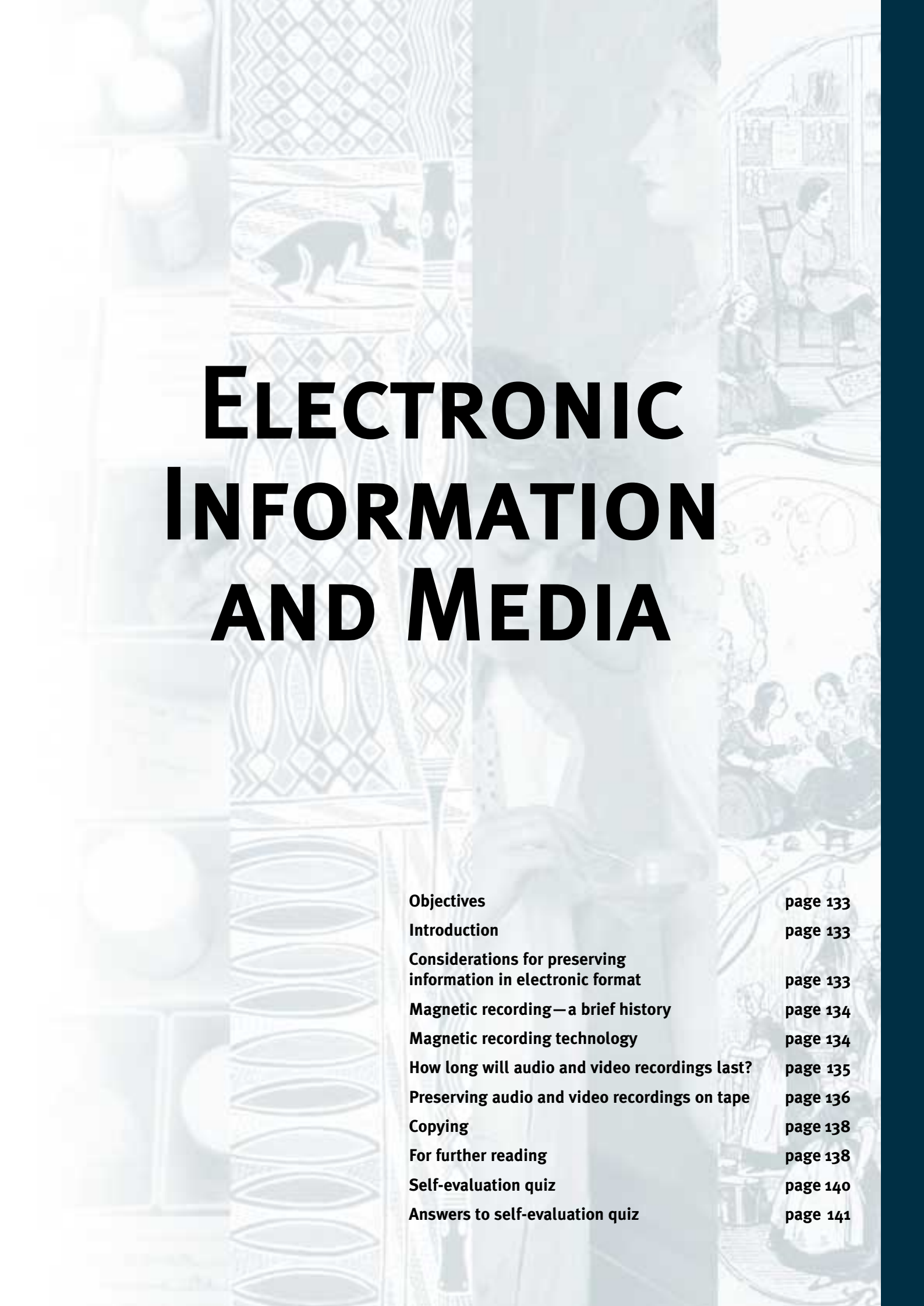

ELECTRONIC INFORMATION AND MEDIA

Objectives	page 133
Introduction	page 133
Considerations for preserving information in electronic format	page 133
Magnetic recording—a brief history	page 134
Magnetic recording technology	page 134
How long will audio and video recordings last?	page 135
Preserving audio and video recordings on tape	page 136
Copying	page 138
For further reading	page 138
Self-evaluation quiz	page 140
Answers to self-evaluation quiz	page 141

Objectives

At the end of this chapter you should be able to:

- describe why electronic information and media don't last;
- describe what can be done to make electronic information and media last longer;
- choose from the available options; and
- set up a preservation program for electronic information and media.

Introduction

Increasingly, museums, galleries and libraries are using electronic media to improve access to their collections, to enhance their documentary collections, as publishing options and as exhibits. As the interest in, and use of, electronic media increases, people are becoming more concerned about preserving these formats.

The main carriers, or media, for electronic information are hard disks, floppy disks, audio tapes, video tapes and CD-ROMs. Preserving electronic information and media is about being able to use them for as long as you want to. However, preserving electronic media is not straightforward. There are two main issues to consider:

- the preservation of the actual item, that is, the CD-ROM or the audio tape; and
- preserving the information.

When it comes to preserving electronic information and media, conservators tend to believe that preserving the information is more important than preserving the media. There are many reasons for this. One of the main ones is the recognition that technology is advancing at such a rate that many of the media used today may be obsolete in the near future. Think about how quickly compact discs—CDs—replaced the once familiar vinyl LP record.

Obviously, if you have invested in a certain technology you will want to protect your investment and be able to use your electronic media for as long as possible. This will require that the carrier and the machine needed to access the information are in good condition. This section gives basic information on caring for electronic

media—with an emphasis on video and audio recordings.

Electronic information is inherently short-lived and at some stage the information will need to be transferred from its present carrier to a new carrier, before the present medium deteriorates or your equipment stops working. This may be in a few years or a decade, but you must plan for this transfer to take place.

In the meantime, this section will help you to care for your electronic media. If you are particularly interested in preserving electronic media, it is strongly recommended that you keep in touch with the latest developments—the library network can help you with this.

Considerations for preserving information in electronic format

Some of the information in archives, libraries and museums is already in electronic format. Most of this information is in analogue format, including audio recordings and video recordings on magnetic tape. Digital magnetic media such as floppy disks, hard disks and magnetic data tape are also being used. This will change as digital recording becomes more widely used.

Preserving electronic information and media is about:

- recognising that electronic preservation raises challenges that are fundamentally different than those encountered in preserving traditional-format materials such as paper and books;
- understanding why access to all magnetic information is going to be short-term;
- setting priorities by choosing what information to keep, and discarding the rest;
- using commonsense techniques to try and make electronic information and media last longer; and
- applying this knowledge systematically.

Magnetic recording— a brief history

The basic principles of magnetic recording were first discovered in the 1890s. Not much was done with the discovery because the necessary electronics hadn't been invented.

Audio recordings on tape were invented in the early 1930s and introduced to the domestic market in the late 1940s.

Several companies tried to develop a videotape recorder in the early 1950s, but Ampex was the first to succeed in April 1956.

The first on-air broadcast of videotaped material occurred on 30 November 1956, with the CBS Douglas Edwards evening news broadcast.

In 1968, Sony introduced the first videotape recorder that was small enough and cheap enough for use in education. It was replaced by the Sony U-Matic cassette recorder in 1971 which was still in use 25 years later.

The videotape recorder was not cheap enough for the consumer until Sony introduced the BetaMax in 1975. In 1976, JVC introduced the VHS VCR, and the battle of the formats began. In 1989, Sony introduced the Hi8 camcorder.

Digital videotape recording started in 1987 when the Society of Motion Picture and Television Engineers established the D1 standard. Digital has a major advantage over the previous analogue-based recorders, because there is no degradation when tapes are copied.

Since the introduction of the D1 format, at least four others have been launched. None of them dominates the market and D1 itself is now virtually obsolete.

Magnetic recording technology

All magnetic tape media consist of three components:

- ferromagnetic recording material, capable of being magnetised when placed in a magnetic field;

- substrate or base material, on which the recording material is coated; and
- a binder which functions as a carrier for the recording material, and bonds it to the substrate.

The magnetic materials used in audio recordings and video recordings are properly described as ferromagnetic. They are characterised by strong, easily detectable, spontaneous and permanent magnetisation—even without an external magnetic field.

Audio information, for example, speech or music, is recorded in the magnetic layer as a continuously varying analogue sound signal. The magnetic signal is made by an electromagnet, which conveys variations in electrical strength from the output of a microphone to the recording medium. On playback, the original sound is reproduced by reversing the process and replacing the microphone with a loudspeaker.

Video information, for example, the moving images filmed at weddings or on holidays, is recorded in the magnetic layer as a continuously varying analogue signal. Sound information on videos is recorded in the same way, but only in narrow tracks along the edges of videos.

The magnetic signal is made by a magnetic field. It can be erased deliberately when a new recording is made. But it can also be altered accidentally by a magnetic field that gets close enough to the recorded signal to alter it.

If magnetised material gets hot enough, the magnetism disappears. The point at which this occurs varies with the recording material. For example, with iron alloys it is 770°C.

Recording materials

The International Electrotechnical Commission—IEM—classify audio tapes into three types: Types I, II and III. A tape's classification is determined by the recording material used.

The gamma form of ferric oxide, iron rust, is the most widely used recording material. It is the recording material for audio cassettes designated as Type I. They are typically described as normal bias tapes.

Chromium dioxide was introduced in the late 1960s as a magnetic material suitable for high-density recording. These are known as IEC Type II—high bias—audio cassettes.

Pure iron particles, the recording material used by so-called metal media, are used in IEC Type III audio cassettes and digital audio tape—DAT—cassettes. They support recording densities approximately three times stronger than gamma ferric oxide particles.

Substrates

With magnetic tapes, the substrate is typically plastic film.

The base materials of early magnetic tapes, some of which may be stored in libraries and archives, were composed of cellulose triacetate or polyvinyl chloride—PVC.

Substrates of newer magnetic tape invariably consist of polyethylene terephthalate—PET—which is often identified by one of its trade names, such as Du Pont's Mylar or Eastman Kodak's Estar and is known in the film industry as polyester. Compared with earlier substrate materials, PET films are stronger and more resistant to high temperatures and humidity.

Binders

Early magnetic tapes featured polyvinyl chloride—PVC—binders. Today, polyethylene binders are commonly used. These binders don't stand up well to high humidity which softens the binder. If the binder has softened to the extent that the particles either move or come right off the base, permanent damage will have been done to the recording. In a dry environment, it is possible that the binder may be re-hardened by reverse hydrolysis to get the sound back.

How long will audio and video recordings last?

The life of a recording is difficult to predict, and opinions vary.

The oldest audio recordings stored in archives are still playable after 40-50 years; and the oldest

video recordings stored in archives are still playable after 30 years.

This potential lifespan is reduced considerably if recordings are not made, stored or used with preservation in mind.

In extreme humidity, deterioration can occur in a few years.

Remember that, even when tapes remain playable, the equipment to play them on may no longer exist.

For more information

For more information on the adverse effects of fluctuations in and extremes of relative humidity and temperature, please see *Damage and Decay*.

Keeping tapes playable

One way to keep tapes playable is gentle use on well-maintained equipment.

Gentle use:

- helps avoid changes in the magnetic signal known as print-through;
- re-tensions—but does not over-tension—tapes;
- gives early warning of physical and chemical deterioration; and
- checks whether recordings and equipment are still working together.

Why don't audio and video recordings last forever?

Recordings are short-lived because of:

- damage from inherent media instabilities;
- damage from various external conditions and events;
- inadvertent erasure;
- print-through effects, that is, changes in the magnetic signal, and wear that can render recorded signals unusable;
- physical damage from careless handling or improperly adjusted equipment;

- contaminants which can cause signal drop-outs;
- inappropriate storage environments, which cause significant chemical damage through hydrolytic degradation of binder materials; and
- equipment obsolescence because the usability of recordings on tape is dependent on complex technology.

Preserving audio and video recordings on tape

Preserving audio recordings and video recordings on tape in archival conditions is not yet fully understood—not as well understood as the archival preservation of paper.

Preserving recordings depends on:

- making a long-lasting recording at the beginning;
- looking after the magnetic signal;
- looking after the binder layer and the carrier layer;
- looking after the equipment used in recording and playing recordings during storage and use; and
- careful and systematic management.

Making recordings with preservation in mind

A good place to start preserving audio recordings and video recordings on tape is with the selection of long-lasting media before a recording is made.

When making recordings, use new tape, and use the highest quality recording media that you can afford. Major brand-name tapes from audio and VCR equipment manufacturers or magnetic products manufacturers are generally of a consistently good quality.

For important recordings, make two copies on tapes drawn from different manufacturing batches.

Comply fully with specifications established by the manufacturer on which the media will be recorded or played.

If you are in the north of Australia in summer or the south of Australia in winter, allow time—about one hour—for your video camera and video tapes to warm up or cool down before use. A rapid change from an air-conditioned room to tropical heat and humidity in the northern summer, or from a heated room to the cold and damp of a southern winter environment, can clog video heads and jam video cassettes.

Looking after the magnetic signal

Magnetic recordings on tape are made and destroyed by strong magnetic fields—such as the permanent magnets in headphones and loudspeakers. The situations and equipment to watch out for are:

- high-voltage power lines;
- lightning arresters in large buildings;
- magnetic flashlights;
- fridge magnets;
- small headphones; and
- speaker cabinets.

You will usually not have to worry about damage from normal household wiring and security scanners and X-ray equipment.

Follow the guidelines below and copy old, fragile or extremely valuable recordings if you listen to them frequently. Copying is known as dubbing.

Before copying, carefully rewind two or three times any tape which has not been used for several years. Careful rewinding relieves any tension in the tape, and reduces the effect of print-through.

Consider using electronic filtering when older recordings are being dubbed onto a new copy. Filtering can sometimes be effective in removing unwanted noise and the effects of wear or damage. Clearly label the original recordings and the copies.

Throw out all damaged tapes after copying them. A damaged tape can damage your equipment and this can damage the rest of your tapes.

Storing and maintaining tapes so they will last

Heat and high humidity are the two greatest enemies of audio and video tapes in storage.

Ideally, store video tapes in an environment where temperature is constant and in the range 18-24°C and where relative humidity is constant and in the range 35-45%.

For more information

For more information about the steps you can take to control relative humidity and temperature, please see *Damage and Decay*.

Achieving these conditions can be difficult, but the following steps will protect your tapes, even when the conditions are not ideal.

Store tapes in an environment that is slightly cooler and drier than is comfortable for humans, in a clean atmosphere and in polythene bags.

Fast-forward and rewind the tapes before storage—make sure that the tapes are correctly wound inside the cassette.

Protect tapes from rapid fluctuations in relative humidity and temperature.

Keep tapes out of direct sunlight and away from local heat sources.

Shelve tapes upright in sturdy shelves with dividing supports every 100mm-150mm. Vertical storage is preferred to horizontal storage, because storing the containers this way helps prevent damage to the edge of the tape.

If several containers are stacked horizontally on top of each other, the plastic cassettes can warp and the player may not accept the tape.

Play tapes to the end, leaving the tape wound smoothly, with only leader or unrecorded tape exposed.

Play tapes through every few years to check their condition and to minimise any tendency for layers to stick together or to print through magnetically.

For reel-to-reel tapes, the hubs used for storing tapes should be smooth and rigid; and tapes should have their ends fastened.

Label cassettes correctly.

Make sure the tape recorder or VCR works before you insert a tape.

CAUTION:

Avoid storing your tapes:

- directly on concrete floors because they are susceptible to spills and water damage, and high humidity;
- in attics or cellars where it is often very hot and the relative humidity is high;
- near bathrooms and laundries or other steamy, damp areas; and
- next to the VCR in an enclosed cabinet because it can get very hot.

Handling tapes to avoid damage

Audio recordings and video recordings need to be handled carefully, to avoid physical damage and contamination. Even when your hands appear clean, traces of sweat and oil are present, which can attract dust or promote mould growth when deposited on a recording.

Handle magnetic media carefully, avoiding skin contact with magnetic surfaces—handle the cassette only.

Prohibit eating, drinking and smoking in all areas where magnetic media are used or stored.

Carry reel-to-reel tapes by the hub or centre.

Don't carry your video camera or video tapes in a bag with liquids or food that could damage the video materials.

If the materials are being used outside of the archive, library or museum, provide staff and users with specific instructions.

For more information

For more information on the adverse effects of dust and mould, please see *Damage and Decay*.

Looking after equipment

Clean and adjust all recording and playback equipment regularly according to the manufacturer's instructions, making sure that the recordings themselves are clean.

Clean heads and guides, rollers and other components in the tape path with a swab of isopropanol—rubbing alcohol.

CAUTION:

Use cleaning tapes only as a last resort. Some types can cause premature head-wear or damage. Two types of cleaning tape are available. It is preferable to use the wet type rather than the dry, abrasive type.

Copying

Copying audio and video recordings on tape is an essential routine aimed at:

- preventing damage to originals through handling and playing;
- providing security copies, in case the originals are damaged or stolen; and
- ensuring the permanent preservation of recordings as the original carriers deteriorate.

Transfer important recordings to the latest available mainstream technology every five years or so—one source states every two or three years—to check the playability of the recording and to make sure it can be played on easily available equipment.

Make one recording per tape. Choose good-quality, polyester-based, ferric oxide-coated, standard-play, magnetic tape. Record in analogue mode.

Develop a standard procedure and make a written record of each tape copied—so that all copies will have uniform and predictable characteristics.

Do not use spliced tapes.

Leave the first two metres of each copy tape blank.

Precede each audio recording on a copy tape with a spoken announcement, giving the reference of the original, the numerical reference of the copy and a brief description of the item.

If you have a problem related to the care of electronic media, contact a conservator. Conservators can offer advice and practical solutions.

For further reading

Preserving audio recordings

Brandis, Leanne 9 December 1993, *Magnetic tape deterioration*, Conservation DistList, URL <http://www.palimpsest.stanford.edu/>.

National Film & Sound Archive c 1990, *How to care for your audio collection*, National Film & Sound Archive, Canberra, Australia.

Nishimura, Douglas 13 December 1993, *Magnetic tape deterioration*, Conservation DistList, URL <http://www.palimpsest.stanford.edu/>

Stielow, Frederick J. 1986, *The management of oral history sound archives*, Greenwood Press, Westport, Connecticut.

Ward, Alan 1990, *A manual of sound archive administration*, Gower Press, Aldershot, UK and Brookfield, Vermont, U.S.A.

Smith, Leslie E. 1991, Factors governing the long-term stability of polyester-based recording media, *Restaurator*, Vol. 12 (4), Munkgaard International Publishers Ltd, Copenhagen, pp 201–18.

Preserving video recordings

Association for Moving Image Archivists—AMIA-L List server. To subscribe send an email message to listserv@ukcc.uky.edu with the following text as your message:

“subscribe AMIA-L first-name family-name”.
For example: ‘subscribe AIMA-L Alan Howell’
Important: Do not put any other text in the subject or cc message boxes.

Bogart, John W. C. 1995, *Magnetic tape storage and handling: a guide for archives and libraries*, Washington, D.C.: Commission on Preservation and Access and St. Paul, MI: National Media Laboratory. All Commission on Preservation and Access

publications are available from the Commission at 1400 16th Street, NW, Suite 740, Washington, D.C. 20036-2217. Phone +1 202 939 3400, Fax +1 202 939 3407.

Botte, David 1992, *A basic guide to colour TV and VCRs: An Electronics Australia publication* Federal Publishing Company, Alexandria, NSW.

Boyle, Deirdre 1993, *Video preservation: securing the future of the past*, Media Alliance, New York.

Boyle, Deirdre 1996, *Forgetting tomorrow: preserving the present and the past for the future* *The Helix*, CSIRO Publishing, Collingwood, Vic, pp 11–12.

National Film & Sound Archive c1990, *How to care for your videos*, National Film & Sound Archive, Canberra, Australia.

Saffady, William 1991, Stability, care and handling of microforms, magnetic media and optical disks, part two, magnetic media, *Library Technology Reports*, Vol 20 (1), American Library Association, Chicago.

Smith, Leslie E. 1991, *Factors governing the long-term stability of polyester-based recording media* *Restaurator*, Vol 12, Munkgaard International Publishers, Copenhagen, pp 201–218.

Swartzburg, Susan G. 1995, Image and sound: the care and preservation of motion pictures, sound recordings and videotape, *Preserving library materials: a manual*, The Scarecrow Press, Metuchen, New Jersey & London.

Vidipax, the magnetic media restoration company World Wide Web home page and resources, URL <http://www.panix.com/~vidipax/>.

Waters, Edgar 1995, *Guidelines for audio and audiovisual recording in the South Pacific* National Library of Australia, Canberra, ACT.

Wheeler, Jim, 6 March 1996, *The Current State of American Television and Video Preservation* Statement by Jim Wheeler before the Library of Congress Panel, Listserv AMIA-L@UKCC.uky.edu, Thu, 7 Mar 1996.

Preserving digital information

The Commission on Preservation and Access WWW home-page contains several reports on preserving digital information. Their URL is <http://www-cpa.stanford.edu/cpa.html>

Conservation Online WWW home-page <http://www.palimpsest.stanford.edu/>

Dollar, Charles 1994, Issues for archivists, records managers and IT managers: provenance, obsolescence, standards and preservation, *A window to the future*, School of Library, Archive and Information Studies, University College London, London: International Study Centre for Records Management; Sydney, NSW: Educational Film Services Australia, pp 25–38.

Elkington, Nancy E., ed. 1994, *Digital Imaging Technology for Preservation* Proceedings from an R.L.G. Symposium held March 1994, RLG, Cornell University, Ithica, New York.

Freedman, Alan 1994, *The computer glossary: the complete illustrated dictionary* 7th ed., American Management Association, New York, N.Y.

Howell, Alan *A workshop on the use of digital imaging technology for preservation and access* LASIE, vol. 27, no. 1, State Library of New South Wales, Sydney, pp 26–41.

Kenney, Anne & Chapman, Stephen 1995, *Digital resolution requirements for replacing text-based material: Methods for benchmarking image quality tutorial*, The Commission on Preservation and Access, Washington D.C.

Mohlhenrich, Janice, ed. 1993, *Preservation of electronic formats and electronic formats for preservation*, Highsmith Press, Fort Atkinson, Wisconsin.

Nader, Jonar C. 1995, *Prentice Hall's illustrated dictionary of computing*, 2nd ed., Prentice Hall, Sydney, NSW.

Pilgrim, Aubrey 1995, *Upgrade or repair your PC* McGraw-Hill, New York, N.Y.

Robinson, Peter 1993, *The digitization of primary textual sources* Office for Humanities Communication Publications Number 4, Office for Humanities Communication, Oxford.

Rothenberg, Jeff, 1995, Ensuring the longevity of digital documents, *Scientific American*, vol. 272, (1), Scientific American Inc., New York, pp 24–29.

Schuller Dietrich, Chairman 1995, Recommendations of the Memory of the World Programme International Advisory Committee, Subcommittee on Technology, UNESCO, Paris.

The Commission on Preservation and Access & the Research Libraries Group 1995, *Preserving digital information*, Draft report of the task force on archiving of digital information, Version 1.0. URL <http://www.rlg.stanford.edu>.

Self-evaluation quiz

Question 1.

Which of the following issues must be taken into account when considering the preservation of electronic media?

- a) The preservation of the actual item, that is, the CD-ROM or the audio tape versus the preservation of the information.
- b) Recognising that electronic preservation raises fundamentally different challenges than the problems encountered in preserving traditional-format materials such as paper and books.
- c) The fact that technological advances will make the media obsolete.
- d) Binders and substrates are adversely affected by high humidity conditions.
- e) All of the above.

Question 2.

Which of the following statements are true?

- a) The life span of a recording is difficult to predict.
- b) The potential lifespan is reduced considerably if recordings are not made, stored or used with preservation in mind.

- c) Video and audio recordings are best kept in conditions of high humidity.
- d) Gentle use re-tensions, but does not over-tension, tapes.

Question 3.

When making recordings with preservation in mind:

- a) use whatever tapes you can, to ensure that costs are kept low;
- b) make two copies on tapes drawn from different manufacturing batches for important recordings;
- c) comply fully with specifications established by the manufacturer on which the media will be recorded or played;
- d) use new tape.

Question 4.

Which of the following statements are false?

- a) Heat and high humidity are the two greatest enemies of audio tapes and video tapes.
- b) The recommended storage conditions for video tapes are: temperature in the range 24–28°C and relative humidity in the range 35–45%RH.
- c) It is recommended that you fast-forward and rewind the tapes before storage, ensuring that the tape is correctly wound inside the cassette.
- d) Vertical storage is preferred to horizontal storage, because storing the containers this way helps prevent damage to the edge of the tape.

Answers to self-evaluation quiz

Question 1.

Answer: e).

Question 2.

Answer: a), b) and d) are true. c) is not true. In extreme humidity the lifespan of recordings is reduced significantly—deterioration can occur in a few years.

Question 3.

Answer: b), c) and d) are correct. a) is wrong. You should use the highest—quality recording media that you can afford.

Question 4.

Answer: b) is false The recommended storage conditions for video tapes are temperature in the range 18–24°C and relative humidity constant and in the range 35–45%RH.

Acknowledgments

Collection Management and Conservation Working Party of the Heritage Collections Council

Margaret Anderson (Chair)
Ian Cook (Deputy Chair)
Karen Coote
Tamara Lavrencic
Jan Lyall
Chris Tassell
Ian MacLeod
Phil Gordon
Robyn Sloggett
John Stanton
Viv Szekeres
Ian Stephenson

Major Contributors

Karen Coote	James Dexter
Keith Fernandez	David Gilroy
Rosie Freemantle	Ian Godfrey
Alan Howell	Vicki Humphrey
Georgia Koronis	Tamara Lavrencic
Ian MacLeod	Joy Noble
Sarah-Jane Rennie	Marion Roubos-Bennet
Robyn Sloggett	Michell Smith
Geoff Speirs	Greg Wallace
Helen Weidenhofer	Margie West

Contributors

Phil Alderslade	Marie Boland
Peter Cahalan	Glenn Cole
Sarah Feijen	Fred Francisco
Helen Halley	Charlotte Jenkin
Gillian Leahy	Sophie Lussier
Holly McGowan-Jackson	Elizabeth Murphy
Kristin Phillips	Alex Roach
Jennifer Ross	Sue Valis
Sandra Yee	

Kimba and Gawler Ranges Historical Society
Migration Museum
National Motor Museum
South Australian Telstra Historical Collection

Other

Stuart Anderson	Simone Cordeauz
Sandra Flischer	Michelle Koford
Jacki Kossatz	Linda Marlin
Simon Prince	Carly Romiero
Slade Smith	Robyn Thomas
Di Virgil	Guthrie Watson

Prototype Development Consortium Conservation Training Australia

Artlab Australia
History Trust of South Australia
Museum and Art Gallery of the Northern Territory
State Library of New South Wales
University of Melbourne Conservation Service
Western Australian Museum

Project Manager: Keith Fernandez
Technical Editor: Vicki Humphrey

Field Trial Participants

Bob Alford	Elizabeth Anya-Petrivna
Denise Davis	Luan Dunaan
Christine Ewings	Jude Fraser
Ann Gibson	Ken Hodge
Jean Johnson	Narayan Khadekar
Lindsay Knowles	Heather Kriesl
Nicole Livermore	Zoe McKenzie-Smith
John Reid	Pauline Ross
Glen Smith	

Sunshine and District Historical Society

Marketing Research

Environmetrics

Editing and Publishing

Communication Partners
Cyranet